

PS-310 and PS-610

DIGITALLY CONTROLLED

DIMMER PACK

OPERATOR'S MANUAL

INTRODUCTION

Dimmer packs are the workhorses of stage lighting systems; they translate the signals produced by the lighting control consoles into the power levels needed to drive the lights to the required intensity. The **sunn** PS-310 and PS-610 are low- and medium-power (300 and 600 watts respectively) dimmer packs each having four independent channels. Both dimmer packs may be programmed to respond to four of a possible 32 channels, making them suitable for use in large systems.

Like all SUNNSPOTS™ components, the PS-310 and PS-610 include digitally controlled SUNNPLEX™, a multiplexing system that allows the various parts of the lighting system to be interconnected by way of standard three conductor microphone cables. This eliminates the fragile and expensive multi-wire snakes required by other lighting systems. The application of this technology to stage lighting equipment makes system setup and operation easy and convenient. Also, in most cases, SUNNPLEX™ allows coded lighting control signals to be sent through audio snakes without interference to other signals.

RFI filtering on all AC outputs minimizes potential interference to audio systems. In addition, the AC power, grounds and control inputs are isolated from each other, reducing noise and providing safe electrical operation.

UNPACKING

After unpacking, inspect for any damage that may have occurred during shipment. If such damage has occurred, notify your dealer immediately, as only he may initiate a claim with the carrier for shipment damage. Be sure to save the packing containers as evidence for the carrier's inspection. Keep packing containers for any future shipping needs.

JACKS AND OUTLETS AND "POWER ON" LED

The **sunn** PS-310 and PS-610 dimmer packs are very similar, differing only in the number of outlets provided and the power handling capability. The PS-310 has four outlets, each of which may supply up to three hundred watts of AC power to its lights; the PS-610 has four pairs of outlets, with each pair capable of supplying up to six hundred watts total.

Figure 1 shows the main panel of the dimmer pack. Because of the similarity between the PS-310 and the PS-610, only the PS-610 is shown.

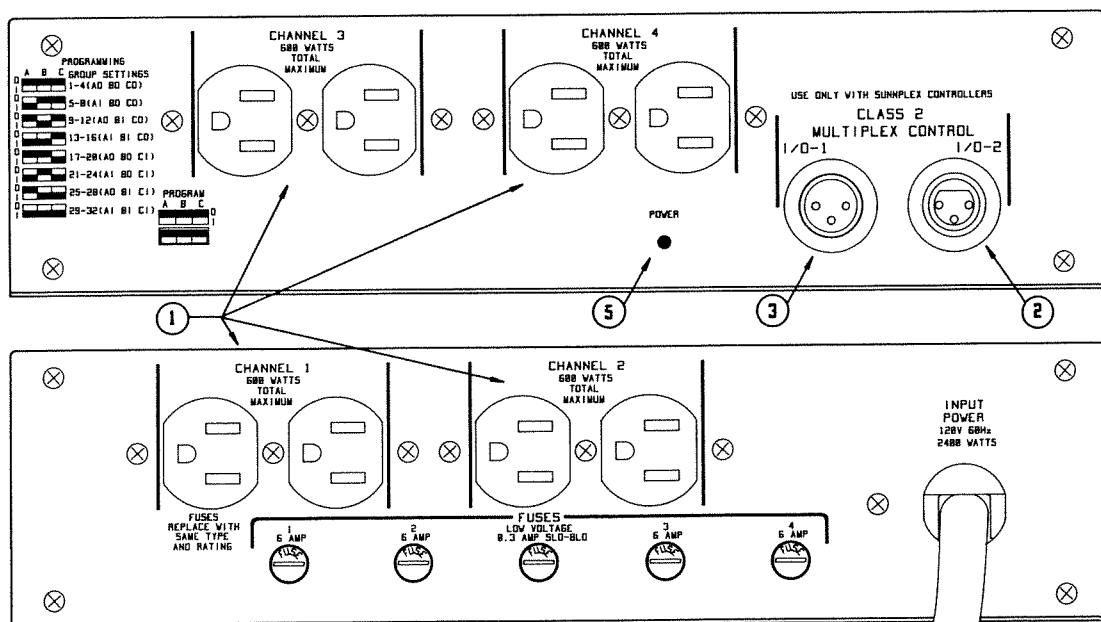

1. AC OUTLETS. These standard three-prong AC outlets provide the power used by the lamps of the lighting system. The amount of power provided by these outlets at any given time is determined by the lighting control signals received from the lighting control console. On the PS-310, each outlet corresponds to one lighting control channel and can provide up to 300 watts of power. On the PS-610, each PAIR of outlets corresponds to one channel, with each outlet of a pair being wired in parallel with the other outlet of that pair. The total power available from a pair is 600 watts (e.g., one 600 watt lamp plugged into one outlet of a pair and nothing plugged into the other; or two 300 watt lamps, with one lamp on each outlet of the pair).

CAUTION: The outlets on the dimmer packs are ONLY for lighting fixtures. DO NOT connect guitar amps, PA equipment, fans, refrigerators to the outlets. Extension cords, however, may be connected between the outlets and the lighting fixtures. FAILURE TO OBSERVE THE ABOVE PRECAUTIONS MAY VOID THE WARRANTY AND CAUSE DAMAGE TO THE DIMMER PACK AND TO THE CONNECTED EQUIPMENT.

2. CONTROL SIGNAL INPUT JACK. This female 3-pin XLR jack connects to a standard balanced, shielded microphone cable and receives the SUNNPLEX™ lighting control signals, either directly from the lighting control console, or from another dimmer pack which is connected directly or indirectly to the control console. The CONTROL SIGNAL INPUT JACK also supplies the DC power which “phantom power” some of the SUNN Controllers.
3. SYSTEM EXPANSION JACK. This male 3-pin XLR jack is wired in parallel with the CONTROL SIGNAL INPUT JACK, and may be used to supply the lighting control signals to another dimmer pack in systems employing more than one dimmer pack.
4. AC POWER CORD. This is the main power cord for the dimmer pack; it ultimately carries all of the AC power consumed by the lights connected to the dimmer pack. It must be plugged into an outlet capable of supplying the total power drawn by the lights (see the section on HINTS AND CAUTIONS).
5. “POWER ON” LED. This LED (Light Emitting Diode) lights whenever the dimmer pack is plugged into a working AC outlet.

SYSTEM INTERCONNECTION

A dimmer pack may be connected via a standard balanced, shielded mic cord (and/or an audio snake) to the rest of the lighting system in two ways: either directly to the lighting control console; or by way of another dimmer pack which is connected to the control console (either directly, or indirectly via still other dimmer pack(s)). Figure 2 illustrates these two methods.

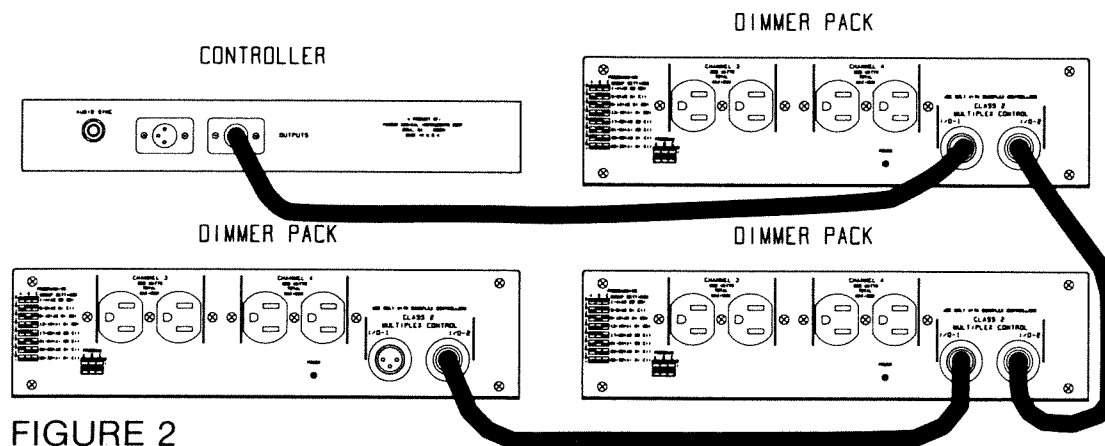

FIGURE 2

MOUNTING THE DIMMER PACK

PS-310 and PS-610 dimmer packs may be attached to lighting truss bars or placed on a convenient flat surface.

1. Truss Bar Mounting. The dimmer packs have two mounting flanges, or "ears," for securing them to the middle of a truss bar, or "tree." The truss bars supplied with **sunn's** LG-4 Light Groups are already properly drilled to match the mounting holes in the dimmer pack flanges. Other truss bars may be drilled to-mate with the flange holes, or a 2" auto muffler clamp may be passed through the flange holes to secure the dimmer pack to any pipe or truss bar.
2. Placing Dimmer Pack On A Level Surface. If you choose simply to rest the dimmer pack on a convenient surface, be sure that it is well-protected from curious and careless passersby.

Regardless of where and how you mount your dimmer packs, keep them as close as possible to the lights they drive. Not only is it less expensive to run one extension cord from an outlet to a dimmer pack than it is to run four from the dimmer pack to the lights, but also the "switching transients" generated by the dimmer packs are more likely to be a problem when more extension cords are used. In general, you will have the fewest problems if you:

- Keep the dimmer pack away from low level audio lines.
- Protect the dimmer pack from possible spilled drinks.
- Do not mount or place any audio equipment on or near the dimmer packs. This may result in audio interference problems.

HINTS AND CAUTIONS

Adhering to the following rules will allow you to run your lights safely and with minimum interference to your audio system.

1. Use a power outlet located as close as possible to an electrical service panel (fusebox). It is best if that outlet is on a separate fuse or circuit breaker from your audio equipment.
2. Always use quality 16 gauge (or heavier) grounded extension cords.
3. Make certain that the rating of the breaker or fuse for the chosen outlet is adequate. The required rating (in amps) of the fuse or breaker can be calculated with the formula:

$$I = \frac{P}{E}$$

where
I = the current (in amps),
P = the power (in watts),
E = the voltage (in volts).

In a standard 120 VAC electrical system, 100 watts = 5/6 amp. A safe rule of thumb is to call 100 watts 1 amp. Thus, if you are using four 500 watt bulbs (2000 watts total), you should have at least a 20 amp service.

4. **IMPORTANT!** Do not run any lighting power cords near sensitive audio cables (e.g. mic cords, guitar cords, snakes, etc.).

TROUBLESHOOTING

If your lighting system is not operating properly, first verify that the system is correctly interconnected, and that the dimmer pack is plugged into a working outlet.

The **sunn** PS-310 and PS-610 dimmer packs have a self-test feature built into them; with lights plugged into the dimmer pack, and the dimmer pack plugged into an AC outlet, the lights will come on at full intensity when no mic cord is attached to the dimmer pack. If any light does not come on, the light may be tested by plugging it into a working channel. A light may also be tested by plugging it directly into any 3-prong AC outlet (be careful—the lights get hot, and they are bright). Replace any burned-out lights. If the lights are good, but they still will not light when plugged into certain channels of the dimmer pack; the problem may be caused by one or more blown fuses inside the dimmer pack. These should only be replaced by qualified service personnel.

WARNING: Busses, triacs, heatsinks and parts of the circuit board are at 120 VAC potential. **Do not open the case.** Install only fuses of the same rating indicated on the outer panel.

If a problem only appears when the system is patched together, either the mic cord or the controller is probably at fault. If the "POWER ON" LED went out when the mic cord was plugged in, the cord is shorted and should be repaired or replaced. The mic cord might also be "open-circuited," in which case the LED would remain on. The quickest way to check a mic cord is to swap it with one that is known to be good. If this fixes the problem, repair the faulty cord. If swapping cords does not fix the problem, consult the TROUBLESHOOTING section in your lighting controller operator's manual for more thorough troubleshooting techniques.

One final possibility is that your dimmer pack is set up to respond to channels not present on your controller. This is only likely to be a problem when the dimmer pack has been used in larger systems. See the section on ADDRESS SELECTION for more details.

ADDRESS SELECTION









The **sunn** PS-310 and PS-610 are four-channel dimmer packs, and are factory preset to respond to channels 1-4 of your controller. For use in larger systems, the dimmer packs contain "address selection" circuitry which may be reprogrammed so that they respond instead to channels 5-8, 9-12, 13-16, 17-20, 21-24, 25-28 or 29-32. All SUNNSPOTS dimmer packs use DIP switches to select the channel address assignment. The ADDRESS SELECT TABLE on page 6 indicates the proper position of the switches for the desired channel assignment. The DIP switches are located on the side of the dimmer pack. To assign the dimmer pack to the desired channels, the switches must be placed in the proper position. The more independent lighting channels you have set-up, the more flexibility you will have when creating your lighting "scenes".

NOTE: After you have set the channel assignment of the dimmer pack, write the channel numbers on a piece of tape and stick it to the dimmer for future reference.

WARNING: Before changing switch positions, MAKE CERTAIN THAT THE AC POWER TO THE DIMMER PACK HAS BEEN DISCONNECTED.

ADDRESS SELECT TABLE

PROGRAMMING

	A	B	C	GROUP SETTINGS
0				1-4(A0 B0 C0)
0				5-8(A1 B0 C0)
0				9-12(A0 B1 C0)
0				13-16(A1 B1 C0)
0				17-20(A0 B0 C1)
0				21-24(A1 B0 C1)
0				25-28(A0 B1 C1)
0				29-32(A1 B1 C1)

SERVICE INFORMATION

There are no user-serviceable parts in either the PS-310 or the PS-610. Therefore, any problems should be referred to qualified service personnel. Contact your dealer for the location of the nearest **sunn** Authorized Service Center.