



**PX 2008/2012
POWERED
MIXING CONSOLE**

P/N 037321

PX20XX POWERED MIXER OWNERS MANUAL

- I. INTRODUCTION
 - A. INTRODUCTION
 - B. HOW TO USE THIS MANUAL
 - 1. TO GET YOU STARTED
 - 2. AS A REFERENCE GUIDE
- II. FEATURES AND CONTROLS
 - A. FRONT PANEL FEATURES
 - 1. CHANNEL CONTROLS
 - 2. MASTER CONTROLS
 - B. PATCH PANEL FEATURES
 - C. REAR PANEL FEATURES
- III. BLOCK DIAGRAM
- IV. USER'S GUIDE
- V. SYSTEM EXAMPLES
- VI. TROUBLE SHOOTING
- VII. SPECIFICATIONS
 - A. GAIN LEVEL DIAGRAM
 - B. SPECIFICATION SHEET
 - C. RESPONSE CHARTS
 - 1. CHANNEL EQ
 - 2. GRAPHIC EQ

I. PX20XX POWERED MIXER INTRODUCTION

The PX20XX is the first in a series of new powered mixing consoles from SUNN. These mixers rely on time proven design methods to achieve the reliability and serviceability you demand.

This mixer is packed with features for a wide variety of applications. The PX20XX will be equally at home whether you are setting up a system for live performance in a large hall, any size club or even a small casual gig.

HOW TO USE THIS MANUAL

TO GET YOU STARTED -

This manual is organized to help you get started using your new SUNN PX20XX Powered Mixer right away! It takes you through the controls and switches on your mixer, one by one, and explains their operation plainly and simply. Then it shows you a block diagram of how the various functions are connected together. The block diagram is a very helpful tool in understanding the many different ways to patch a system together. Following the block diagram, you will find a brief users' guide which provides helpful information about subjects such as BALANCED INPUTS, SIGNAL LEVELS, and IMPEDANCES. Next, you will find a section with suggested system arrangements. The diagrams will assist you in getting the most out of your new mixer by offering creative ways to patch in equipment such as external effects and tape machines. We know you will get a lifetime of quality performance from your new PX20XX Mixer. We have put much effort into making its use easier for you. However, sometimes minor problems do arise. Therefore, we have included a section on trouble shooting with a few suggestions to assist you in determining where a problem may be and what to do to correct it.

AS A REFERENCE GUIDE-

Once you are familiar with the basic operation of your SUNN PX20XX Mixer, you may wish to refer every now and then to the specifications section and to the block diagram for your mixer. Both of these sections are located near the middle of this manual. If you would like a quick review of the operation of a particular control or a switch, find its heading in the table of contents, and review the block diagram or other sections as you wish for that control or switch.



Typical Channel Controls

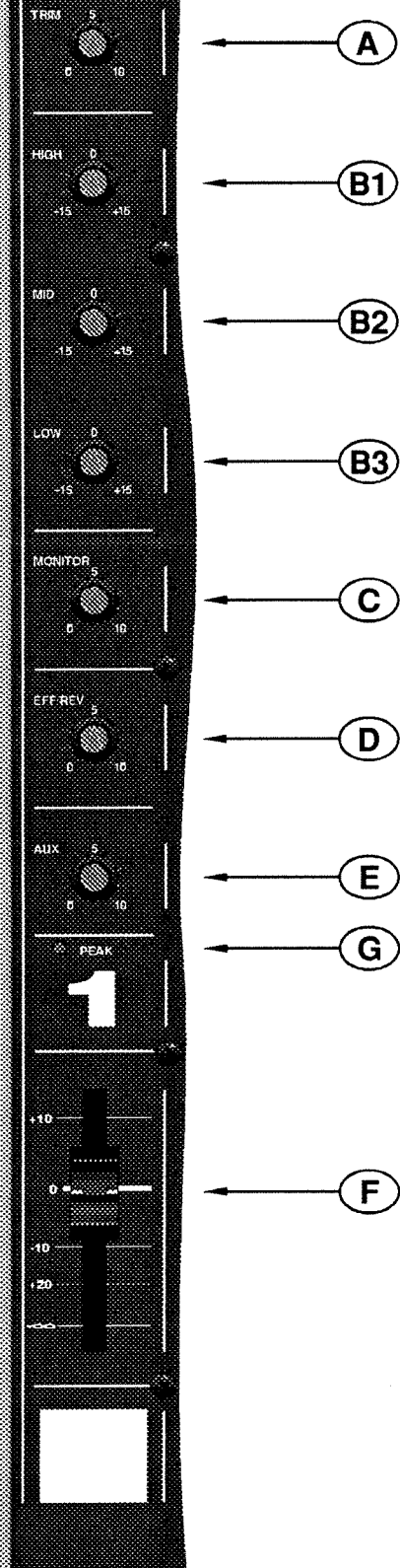

Master Controls

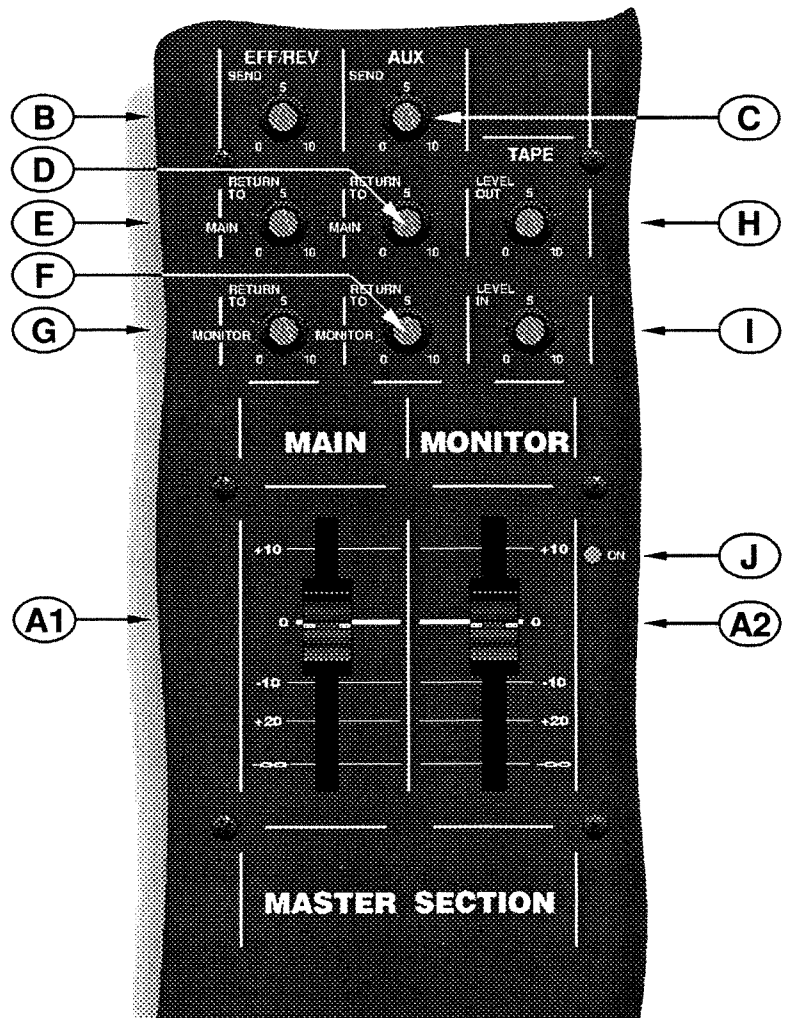

II. PX20XX FRONT PANEL FEATURES

TYPICAL CHANNEL CONTROLS

A. TRIM

Input channel preamplifier gain control.

B. EQ

1. HIGH

Treble tone control, +/- 15 dB, 10KHz shelving type HIGH frequency EQ control post trim control, pre fader.

2. MID

Midrange tone control, +/- 15 dB, 500Hz peaking type midrange EQ control post trim control, pre fader.

3. LOW

Bass tone control, +/- 15 dB, 50Hz shelving type low frequency EQ control post trim control, pre fader.

C. MONITOR

Controls input channel level in the monitor mix. Post trim control, pre EQ, and pre fader.

D. EFF/REV SEND

Controls input channel level in the effects mix. Post trim control, post EQ, and post fader.

E. AUX SEND

Controls input channel level in the auxiliary mix. Post trim control, post EQ, and post fader.

F. LEVEL

Controls input channel level in the main (house) mix. Post trim control, post EQ.

G. PEAK LIGHT

The Peak LED lights when high level signal is present in the channel. Prior to the onset of actual clipping, the peak LED should light occasionally on normal program peaks. Use in conjunction with trim control to set input channel gain.

MASTER CONTROLS

A. MASTER FADERS

1. MAIN

Controls overall main (house) mix level coming out of the mixer, and then feeding the on-board graphic equalizer and power amplifier.

2. MONITOR

Controls overall stage monitor mix level.

B. EFF/REV SEND

Controls overall effects / reverb mix level fed to main and monitor mixes. Effects / reverb mix is received from internal reverb or from effects return jack.

C. AUX SEND

Controls overall auxiliary mix level fed to main and monitor mixes. Auxiliary mix is received from auxiliary return jack.

D. AUX RETURN TO MAIN

Controls overall auxiliary mix level fed to main mix. Auxiliary mix is received from auxiliary return jack.

E. EFF/REV RETURN TO MAIN

Controls overall effects mix level fed to main mix. EFF/REV mix is received from EFF/REV return jack.

F. AUX RETURN TO MONITOR

Controls overall auxiliary mix level fed to monitor mix. Auxiliary mix is received from auxiliary return jack.

G. EFF/REV RETURN TO MONITOR

Controls overall effects mix level fed to monitor mix. EFF/REV mix is received from EFF/REV RETURN jack.

Master Controls & Patch Panel

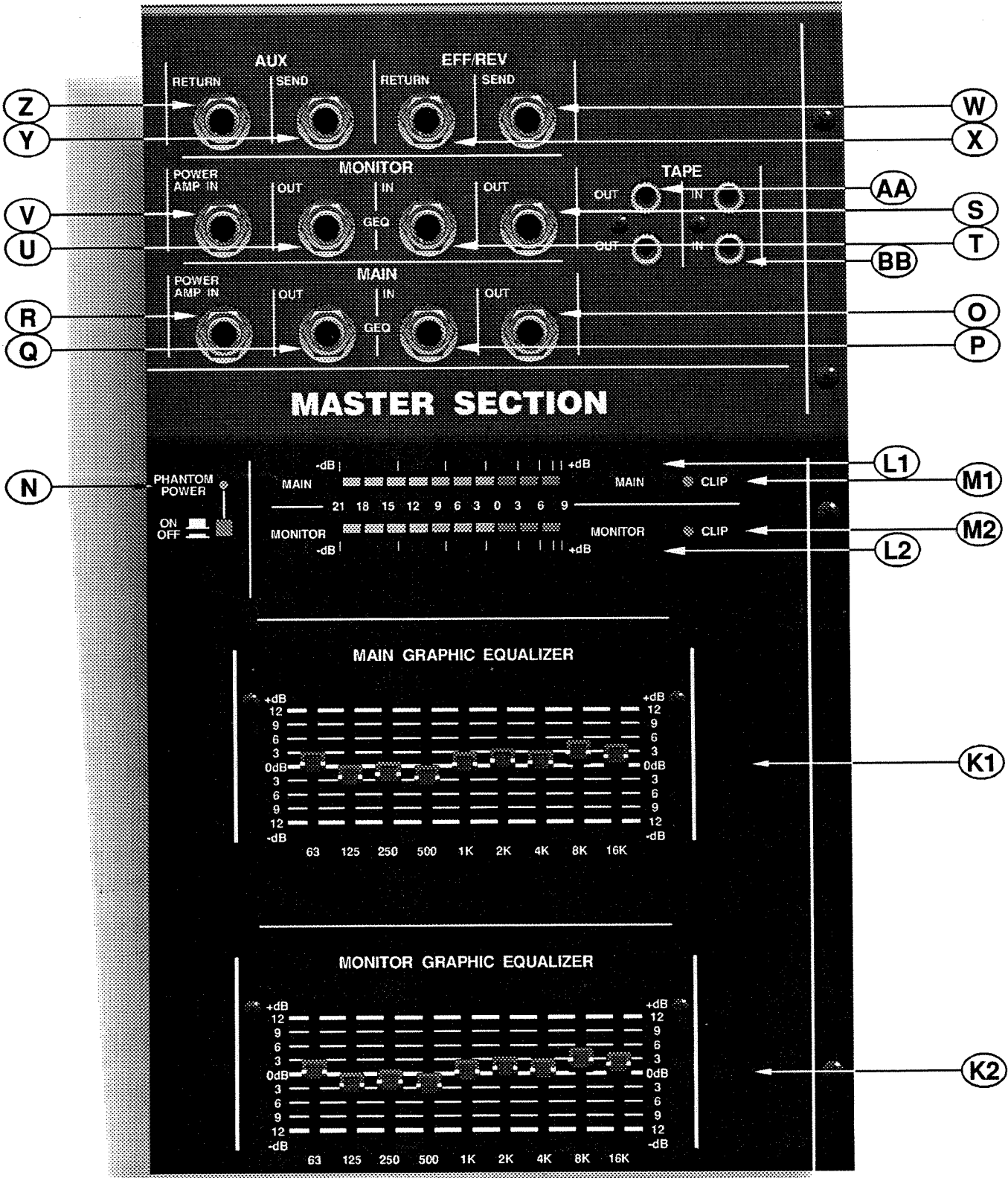

H. TAPE LEVEL OUT

Controls the output level of the main mix being fed to the tape out RCA phone jacks. Use this to set your record levels when taping a live performance. Although it will be a mono recording, two jacks are provided for use with any stereo recorder.

I. TAPE LEVEL IN

Controls the tape playback level in your main mix. The tape inputs are the tape in RCA phone jacks. Although playback is in mono, two jacks are provided for use with any stereo tape player.

J. POWER LED

When "ON", AC power is being supplied to the PX20XX.

K. GRAPHIC EQUALIZER

1. MAIN GRAPHIC

+/- 12dB, 9 band graphic equalizer. This is normally connected to the main output of the mixer section. The output from this equalizer normally feeds the main (house) power amplifier input. The equalizer may be patched to another signal however, by using the equalizer input and output jacks (see page 6).

2. MONITOR GRAPHIC EQUALIZER

+/- 12dB, 9 band graphic equalizer. This is normally connected to the monitor output of the mixer section. The output from this equalizer normally feeds the monitor power amplifier input. The equalizer may be patched to another signal however, by using the equalizer input and output jacks (see page 6).

L. METERS

1. MAIN METER

Displays the level of the signal presented to the main (house) power amp in jack. This is normally the main output of the mixer fed through the main graphic equalizer.

2. MONITOR METER

Displays the level of the signal presented to the monitor power amp in jack. This is normally the monitor output of the mixer fed through the monitor graphic equalizer.

M. CLIP LIGHTS

1. MAIN CLIP LIGHT

Indicates the onset of clipping in the main power amplifier signals in the output channel. The clip LED is an overload indicator, and should light only occasionally on program peaks. Continuous clipping can damage speakers, and cause distorted sound.

2. MONITOR CLIP LIGHT

Indicates the onset of clipping in the monitor power amplifier signals in the output channel. The clip LED is an overload indicator, and should light only occasionally on program peaks. Continuous clipping can damage speakers, and cause distorted sound.

N. PHANTOM POWER

When "ON", the phantom LED indicates the presence of +15 VDC phantom power at all LOW-Z microphone inputs.

PX20XX PATCH PANEL FEATURES

MAIN PATCHES

O. MAIN OUT

Unbalanced main mix output. May be used without affecting the signal to the main equalizer and power amplifier. 1/4" phone jack, with an unbalanced, line level output.

P. MAIN EQ IN

Unbalanced graphic equalizer input. Inserting a 1/4" plug disconnects the output of the main mixer, thus interrupting the signal flow. Use this and the main EQ output jack to patch this equalizer into another signal path. 1/4" phone jack, with an unbalanced, line level input.

Q. MAIN EQ OUT

Unbalanced main graphic equalizer output. May be used when power amp out is in use. 1/4" phone jack, with an unbalanced, line level output.

R. MAIN POWER AMP IN

Unbalanced power amplifier input. Inserting a 1/4" plug disconnects the output of the main mixer and equalizer outputs from the power amplifier. Use this to feed another signal into the power amplifier.

MONITOR PATCHES

S. MONITOR OUT

Unbalanced monitor mix output. May be used without affecting the signal to the monitor equalizer and power amplifier. 1/4" phone jack, with an unbalanced, line level output.

T. MONITOR EQ IN

Unbalanced graphic equalizer input. Inserting a 1/4" plug disconnects the output from the monitor mixer, thus interrupting the signal flow. Use this and the monitor EQ output jack to patch this equalizer into another signal path. 1/4" phone jack, with an unbalanced, line level input.

U. MONITOR EQ OUT

Unbalanced monitor graphic equalizer output. May be used when power amp out is in use. 1/4" phone jack, with an unbalance, line level output.

V. MONITOR POWER AMP IN

Unbalanced power amplifier input. Inserting a 1/4" plug disconnects the output of the monitor mixer and equalizer outputs from the power amplifier. Use this to feed another signal into the power amplifier.

EFF/REV PATCH

W. EFF/REV SEND

Use this to hook up an external signal processor (like a digital reverb). In addition to this patch jack, the signal is also fed to the internal reverb input. 1/4" phone jack with an unbalanced line level output of the effects mix.

X. EFF/REV RETURN

Use this to return the signal from a signal processor. The signal is then sent to the main (house) and monitor level controls, which feed respectively to the main and monitor mix. 1/4" phone jack with an unbalanced line level input.

AUX PATCH

Y. AUX SEND

Unbalanced auxiliary mix output. 1/4" phone jack with an unbalanced line level output.

Z. AUX RETURN

Use this to return the signal from an auxiliary signal processor. The signal is then sent to the main (house) and monitor level controls, which feed respectively to the main and monitor mix. 1/4" phone jack with an unbalanced line level input.

TAPE PATCH

AA. TAPE OUT

Tape record output jack. Dual RCA jack for hooking to a stereo tape recorder's line input jacks.

BB. TAPE IN

Tape playback return to main mix. Dual RCA jack for hooking to a stereo tape player's line output jacks.

PX20XX REAR PANEL FEATURES

A. LINE CORD

Cable for connecting AC power. CAUTION! DO NOT DEFEAT OR REMOVE THE GROUND PIN.

B. POWER SWITCH

Primary AC power ON/OFF switch.

C. SPEAKER CONNECTIONS

Primary main and monitor power amp outputs. PX2008 2X150 watts maximum into 4 ohm minimum impedance. PX2012 2X250 watts maximum into 4 ohm load minimum impedance. One 4 ohm or two 8 ohm loudspeakers per output. 1/4" phone jacks.

D. AIR INTAKE

CAUTION - DO NOT BLOCK! Keep clear for proper cooling.

E. FAN EXHAUST

CAUTION - DO NOT BLOCK! Keep clear for proper cooling.

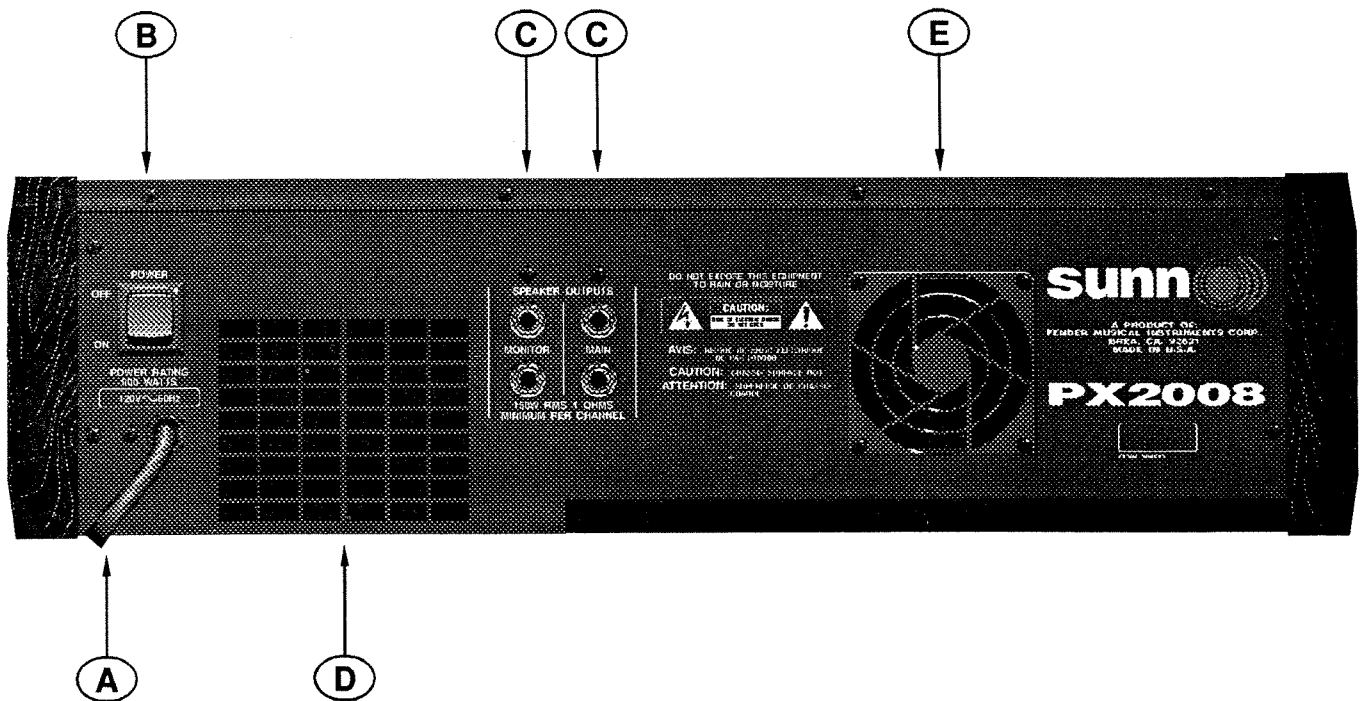

Busses

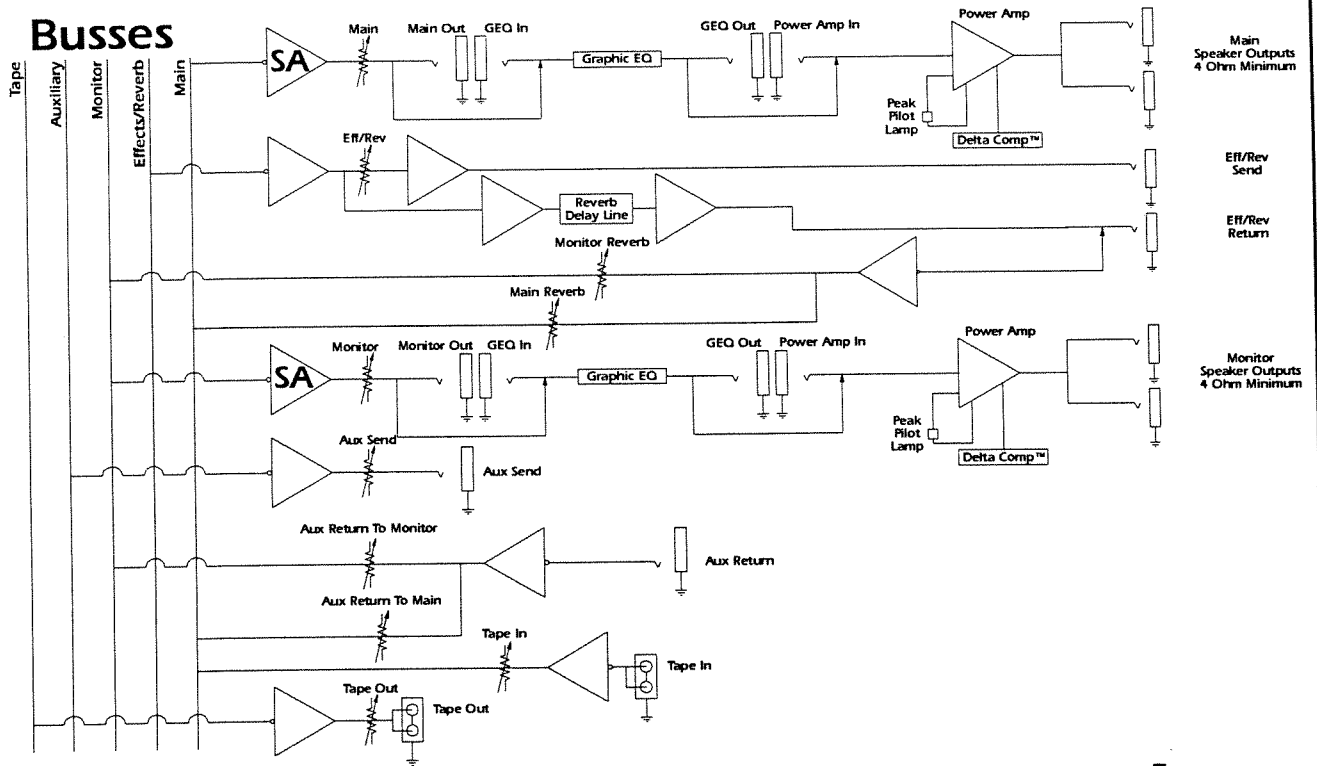

Master Section

Typical Channel

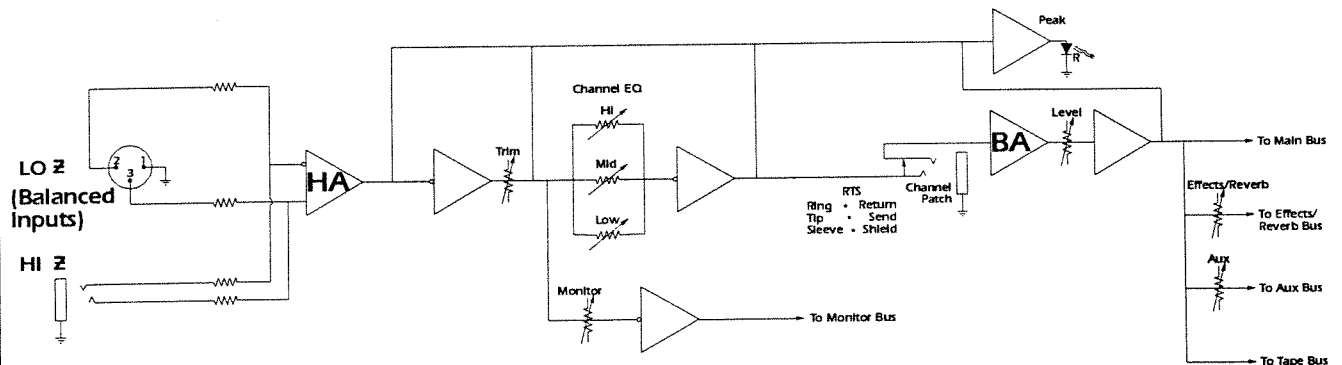

III. PX20XX BLOCK DIAGRAM

The block diagram is a graphic representation of the functions, controls, and patch points in your PX20XX Series Mixer. This diagram can be very useful in helping you set up your mixer to perform the various tasks you need. This diagram may also help you see ways of creatively patching in and out of the mixer with external effects, tape machines, signal processors, etc. Take some time to familiarize yourself with the block diagram and it will prove to be a useful tool to refer to whenever setting up a new system or just optimizing the settings and patches of your familiar configuration.

IV. PX20XX POWERED MIXER USERS GUIDE

HELPFUL HINTS

INPUT CHANNEL EQ

Equalization is a powerful tool and when used carefully can significantly enhance your sound. Used excessively, it can actually hinder the process of sound reinforcement. The trick is to use the input channel equalization controls in a subtle way, making minute changes and listening for the difference. Overuse these controls, by turning them too far up or down, and you risk excessive noise, distortion and a very unnatural sound quality. Therefore, use these EQ controls wisely to enhance your sound and avoid the problem of "over EQ" for the best possible performance.

SIGNAL LEVELS

Signal levels between interconnected components of your system must be watched carefully. All signal levels must stay within a range of compatibility. Connecting components with similar signal level outputs and sensitivities should be one of your first considerations for maintaining good sound quality. If a "HOT" signal is connected to an input with high sensitivity, the result is likely to be distortion. A LOW level signal connected to an input with low sensitivity may require that you turn gain up to noisy levels just to be able to hear the signal. Noise and distortion can detract from even the best performance, so keep the sound quality at its best by maintaining a good match between the signal levels of connected components through out your sound system. Refer to the GAIN/LEVEL diagram in the rear of this manual to help determine sensitivity and INPUT/OUTPUT levels at various points of the PX20XX Mixer circuitry.

IMPEDANCE COMPATIBILITY FOR LINE LEVEL SIGNALS

Active devices, such as effects devices, usually have a wider range of impedance for their input and output connections. While this allows a certain degree of flexibility in your component connections, be careful to observe impedance levels between each component to insure the best treatment of your sound.

IMPEDANCE COMPATIBILITY FOR POWER AMPLIFIER OUTPUTS

Impedance matching is a must when connecting speakers to the power amplifier of your PX20XX Mixer or when connecting a passive crossover network between the speaker and power amplifier. It is always necessary to maintain impedance compatibility when hooking up speakers.

BALANCED AND UNBALANCED LINES

Every audio signal requires at least two wires. In an unbalanced line, the shield (outer conductor) is also one of the audio signal wires. Thus, an unbalanced line needs only the shield and one additional wire (total of two wires). In a balanced line, the shield does not carry audio signal. Thus, a balanced line requires two wires in addition to the shield to carry the audio signal (total of three wires).

In a true balanced line, the audio signal level is "balanced" between the two audio wires and the shield. The primary advantage of a balanced line is that it is much less likely to pick up external noises (hum, buzzing, static, radio stations) than an unbalanced line. Balanced lines should always be used for microphone level signals. For short line level signals, unbalanced lines will usually suffice. Long (50 feet or more) line level signal paths should be balanced. Amplifier output (speaker level, high current) signals are always unbalanced, and should be run with the appropriate gauge and type of cables.

V. PX20XX POWERED MIXER SYSTEM EXAMPLES

A PORTABLE ENTERTAINMENT SYSTEM

This system shows how the SUNN PX20XX Series Mixers can be the heart of a cost-effective, yet versatile pro sound system. This system would be ideal for a small club system.

A LARGER PORTABLE ENTERTAINMENT SYSTEM

In this system, the main (house) mixer output is fed to an external 1/3rd octave graphic equalizer, a compressor/limiter, and an electronic crossover. A pair of external power amplifiers are then used to drive a set of biampable loudspeaker systems. The internal graphic equalizers and power amplifiers in the PX20XX Mixer have been reconnected to power two or more on-stage (foldback) monitors with two separate monitor mixes. In addition, we show an external voice enhancement device used on one microphone via channel patch jacks found on each input channel.

AN INSTRUMENT SUB-MIXING AND STAGE MONITORING SYSTEM

A SUNN PX20XX makes a great keyboard sub-mixer and stage monitor system. The HI-Z inputs can be adapted (using the trim controls) to the outputs of just about any keyboard, and the internal power amplifiers can power local keyboard monitor loudspeakers. The pre amp out jacks in this system are used to feed the main house mixer, while monitor mix is used to drive both the main and monitor equalizers and amplifiers.

A MONITOR MIXING SYSTEM

Larger portable sound systems often have a separate mixer just for the monitors. Because its internal power amplifiers can power the monitor loudspeakers, and its graphic equalizers can help control feedback, a SUNN PX20XX Series Mixer is ideal as a monitor mixer. By using the MAIN, MONITOR, EFFECTS, and AUXILIARY buses, you can do as many as four different monitor mixes on a PX20XX!

AN INDEPENDENT BI-AMPLIFIED KEYBOARD MONITORING SYSTEM WITH SEPARATE SEND TO THE HOUSE P.A.

In this system, each mic and instrument is fed to both the PX20XX and to the main house mixer. A monitor mix from the main mixer is fed into input 1. The players mic and keyboards are fed into the other inputs as required. The main graphic EQ output is fed into an unbalanced electronic crossover, and then to the PX20XX power amps (the mains for low frequency and the monitor for high frequency), and then to bi-ampable monitor speakers. The monitor graphic EQ is patched into one channel using the channel patch insert point.

A FIXED SOUND REINFORCEMENT SYSTEM

In this example, a SUNN PX20XX Mixer is used to provide cost effective yet versatile mixing, equalization and power amplifier capabilities in a small assembly hall, or house of worship sound system.

A SYSTEM USING SUBMIXING

In this system, a SUNN PX20XX Mixer is used as a "submixer" to another larger mixer. The PX20XX's multiple inputs and outputs make it an effective submixer and its internal power amplifiers can be used to provide a house mix plus stage monitoring. In this system, the inputs to the PX20XX Mixer's power amplifiers come from the large, main mixer (both MAIN and MONITOR). That way, the operator can monitor any or all of the inputs to the entire system.

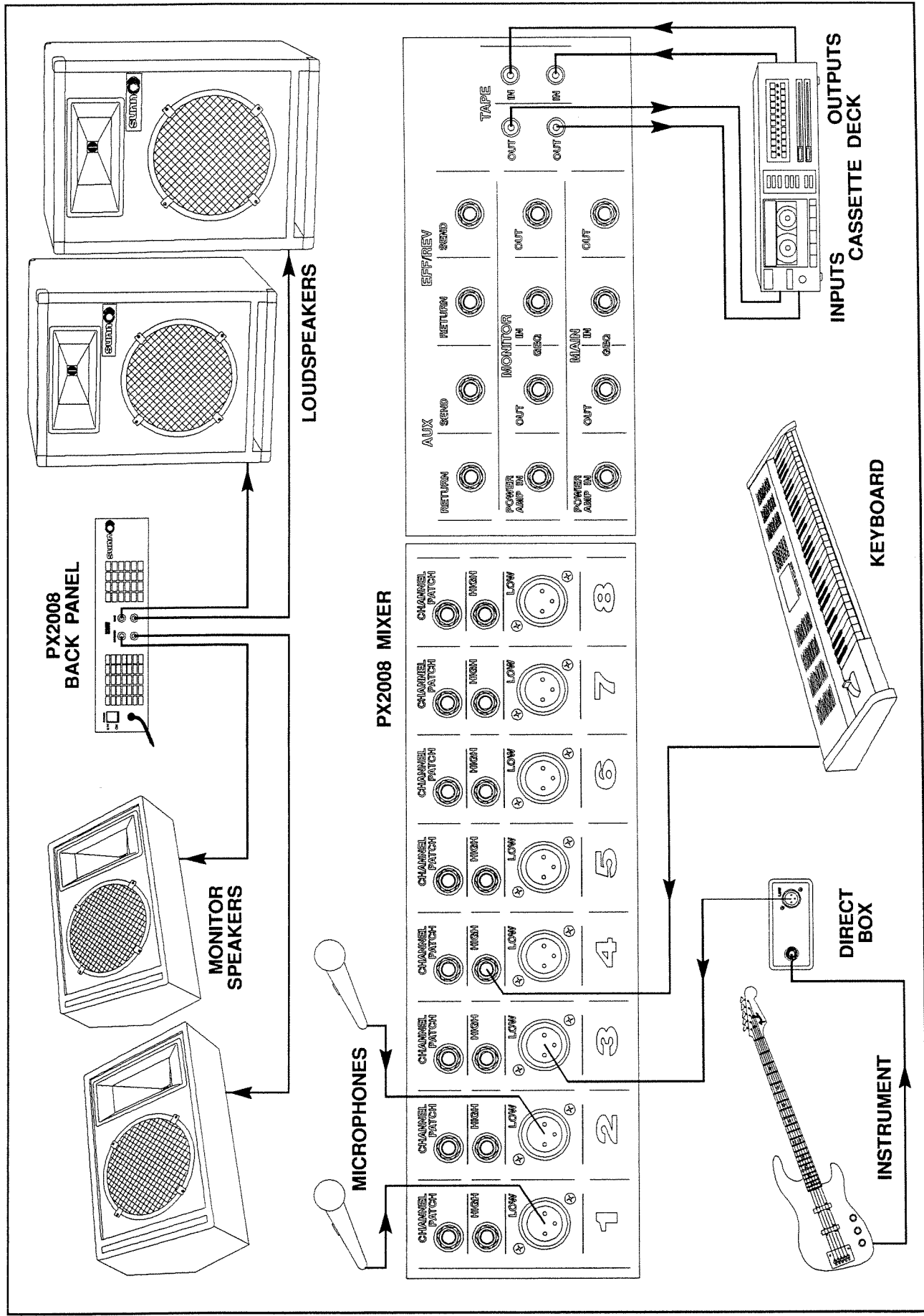

A PORTABLE ENTERTAINMENT SYSTEM

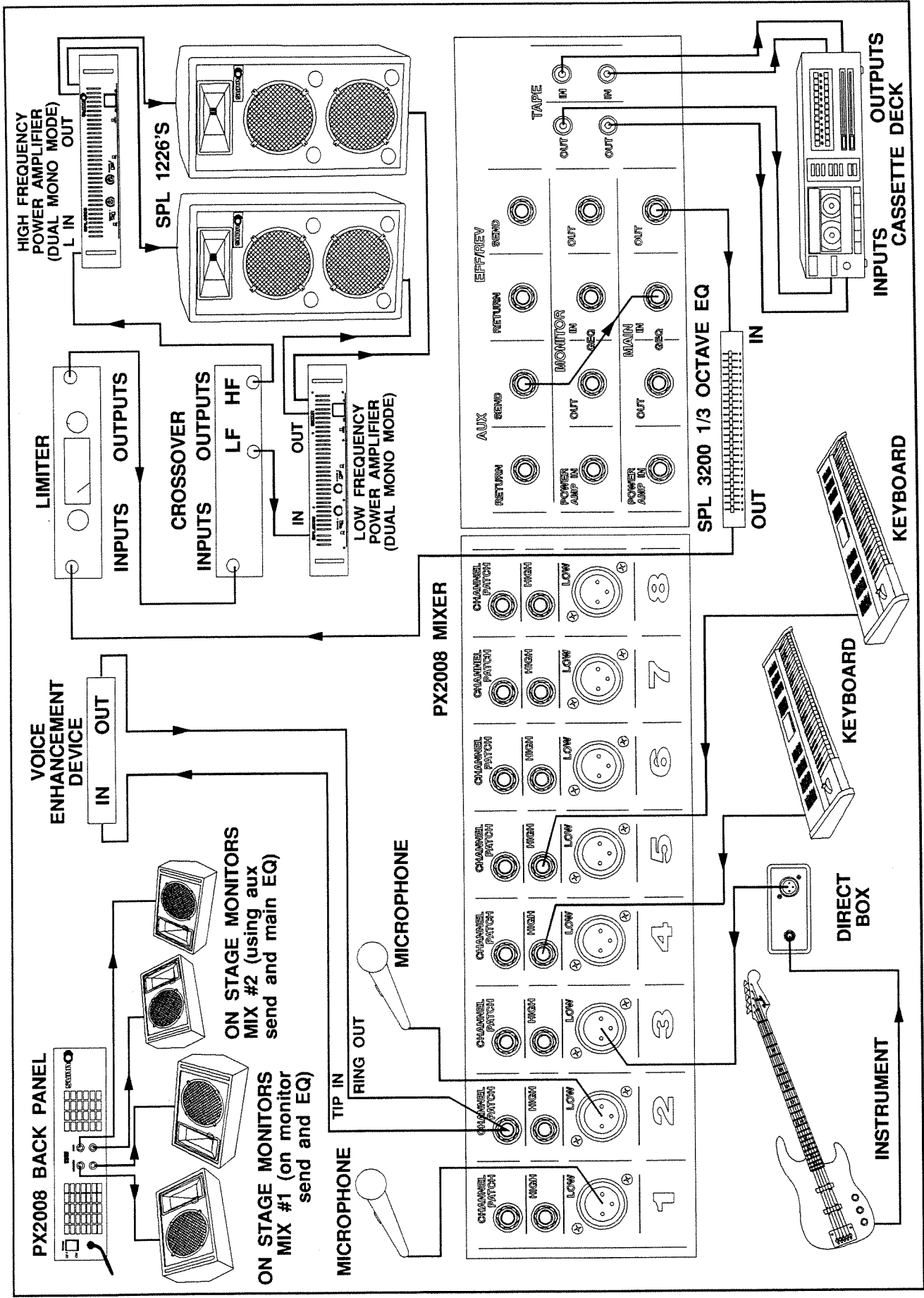

A LARGER PORTABLE ENTERTAINMENT SYSTEM

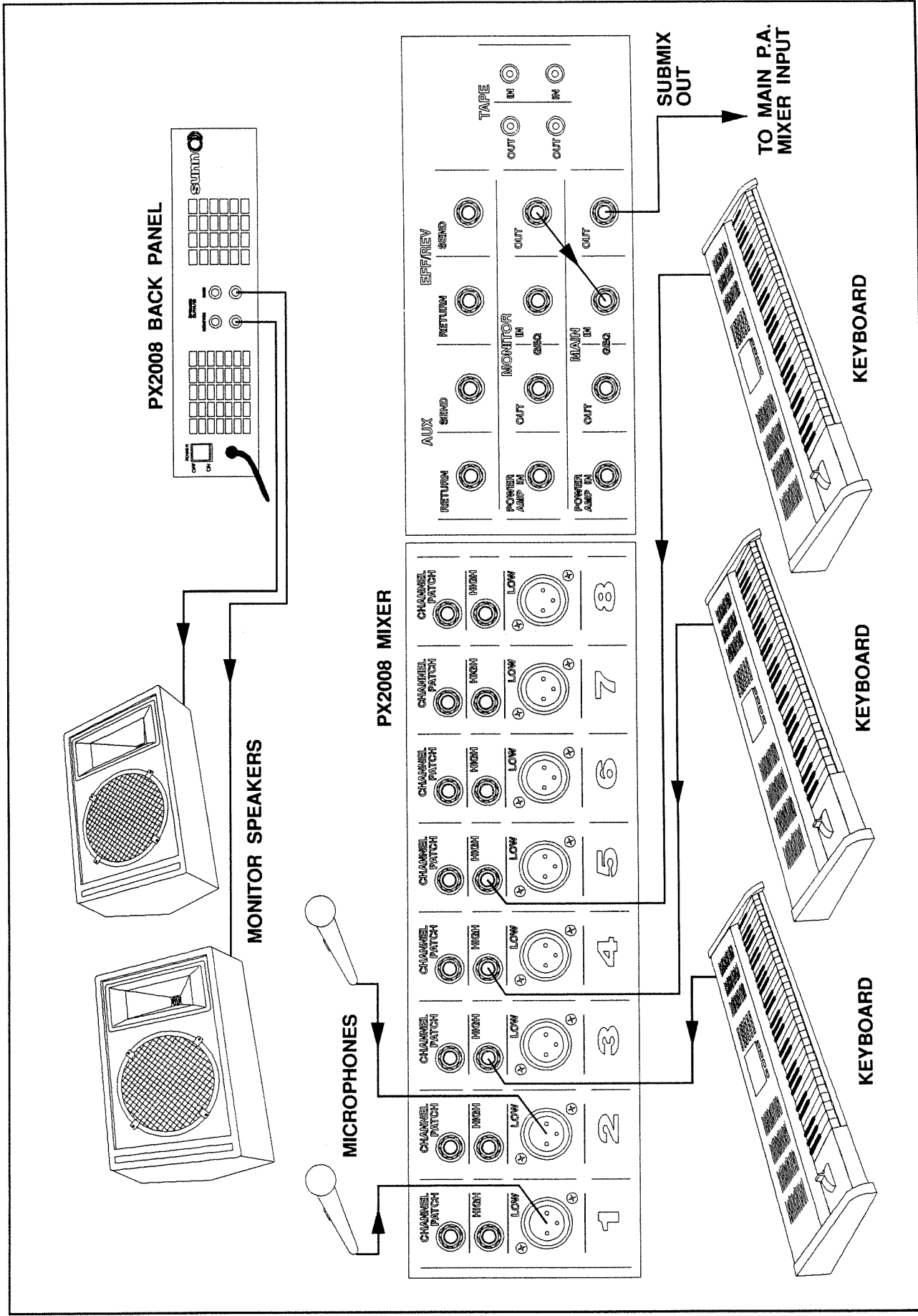

AN INSTRUMENT SUB-MIXING AND STAGE MONITORING SYSTEM

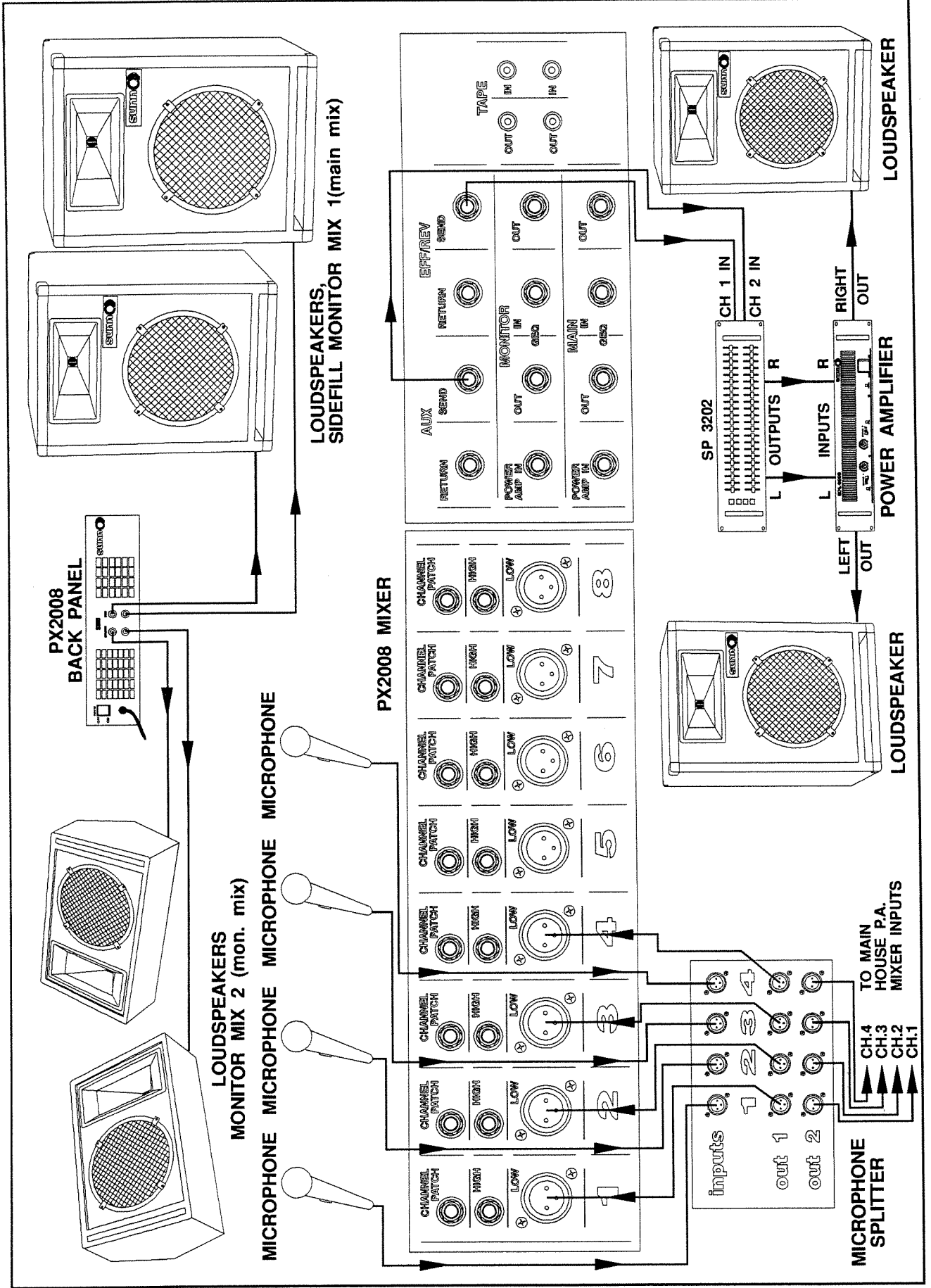

A MONITOR MIXING SYSTEM

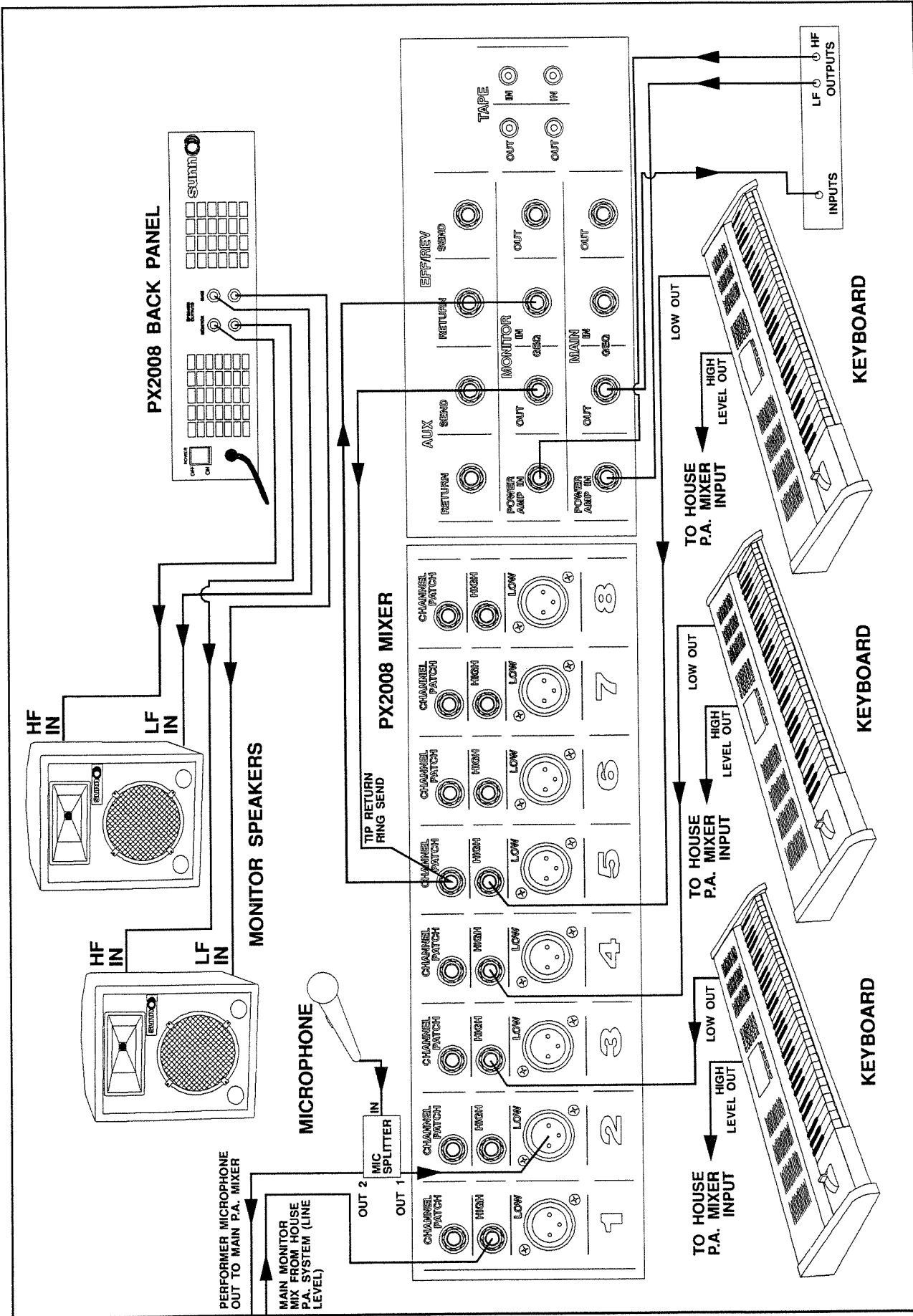

AN INDEPENDENT, ONSTAGE, BI-AMPLIFIED KEYBOARD MONITORING SYSTEM WITH SEPERATE SENDS TO THE HOUSE P.A.

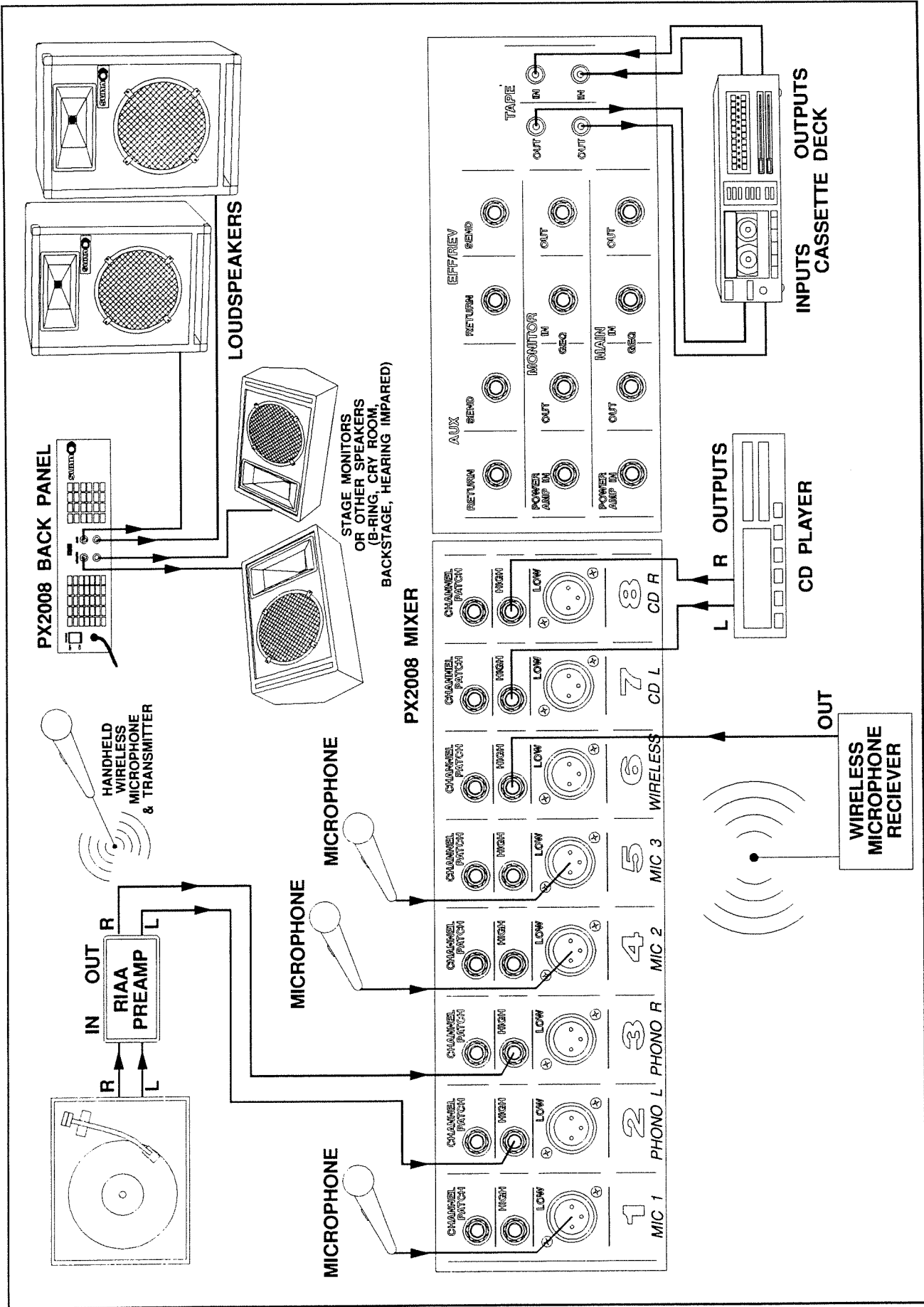

A FIXED SOUND REINFORCEMENT SYSTEM

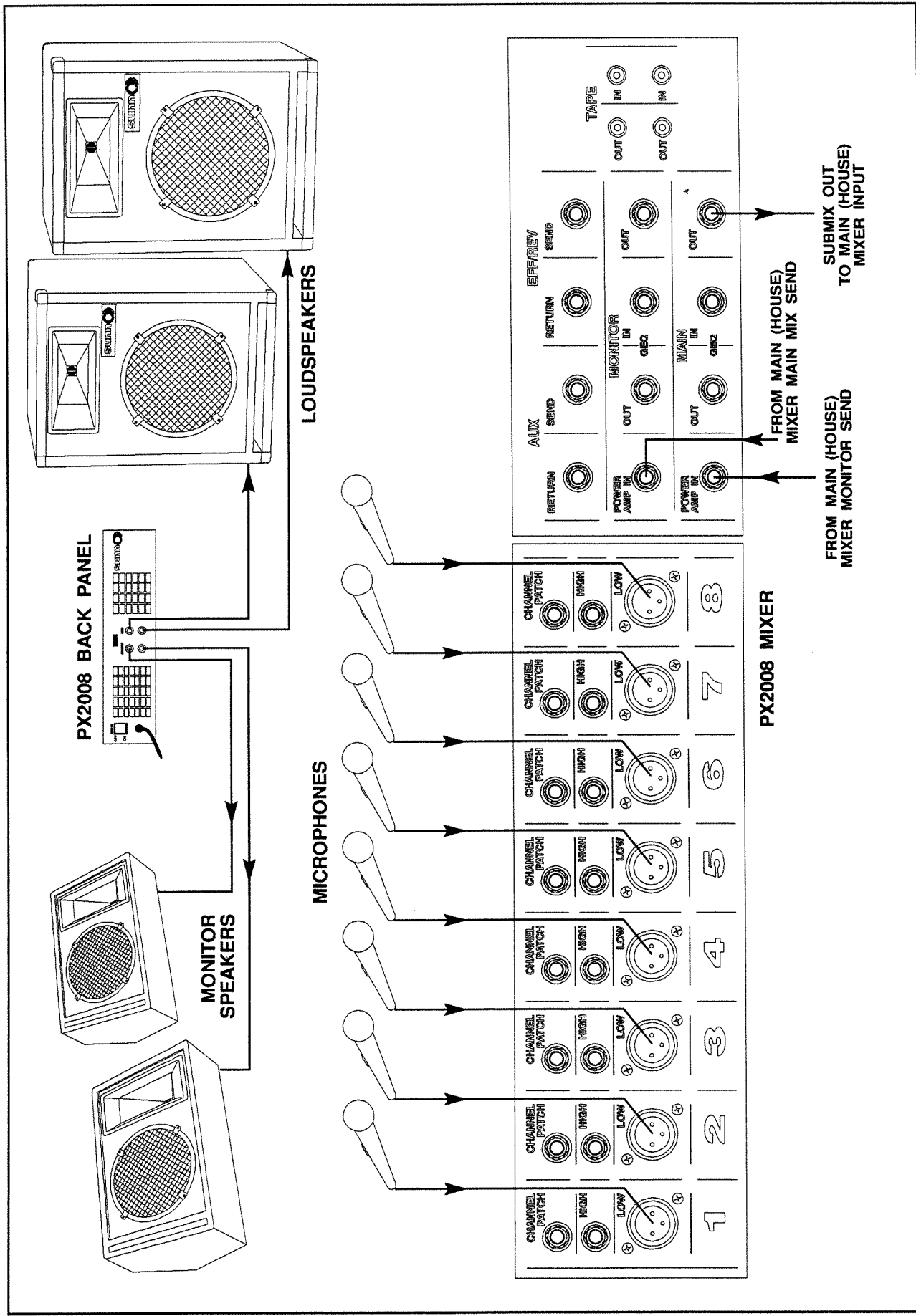

A SYSTEM USING SUBMIXING

VI. PX20XX TROUBLE SHOOTING

WHEN A PROBLEM OCCURS...

The process of trouble shooting involves logical thought and methodical tracking down of a problem by elimination. First, take some time to think through your system connections. It is helpful when trying to trouble shoot a system that you start with the simplest and most obvious things first. Check the power switches on any equipment in your sound system--are they all ON? After establishing that each component in your system is receiving AC power, look at the various indicators on your equipment. What is each piece of equipment telling you about the signal it is receiving? Look for improperly set switches and controls on each component. Proceed to interconnecting cables. Are they all connected properly? Check suspect cables--perhaps a cable is bad or a connector is broken. Try to isolate the fault to a specific component by substituting or patching around it.

A methodical elimination process can track down the source of most problems very quickly. The idea is to find out what component (microphone, cable, mixer, amplifier, loudspeaker) is causing the problem and replace or repair it.

KNOW YOUR BLOCK DIAGRAM...

A sound system block diagram tells you how the various components in the system are connected to each other and what happens to a signal as it flows through the system. Because the block diagram shows the way the sound system operates, it is extremely useful in the trouble shooting process.

KNOW WHAT EACH COMPONENT IS SUPPOSED TO DO...

As obvious as it may sound, you can't tell whether a component is working properly or not unless you know what it's supposed to do in the first place. Thus, it is a good idea to keep instruction manuals on all components handy. Some "repairs" are as simple as repositioning a control knob or throwing a switch that someone has inadvertently changed.

KNOW COMMON TROUBLE SPOTS...

Cables and connectors are by far the most common sources of problems in audio systems. This is the best reason to keep lots of spares, especially of cables that are moved around a lot, like microphone cables. Other common trouble spots are fuses and circuit breakers, switches and controls that are in the wrong positions, and problems with house AC power.

VII. PX20XX PERFORMANCE SPECIFICATIONS

FREQUENCY RESPONSE

PX2008 POWER AMP 20 Hz to 20 kHz \pm 1dB @ 2X150 watts/4 ohms
PX2012 POWER AMP 20 Hz to 20 kHz \pm 1dB @ 2X250 watts/4 ohms
MIXER 20 Hz to 20 kHz \pm 1dB

THD

PX2008 POWER AMP Less than .05% from 20 Hz to 20 kHz, 2X150W
PX2012 POWER AMP Less than .05% from 20 Hz to 20 kHz, 2X250W
MIXER Less than .035 from 20 Hz to 20 kHz, +8dBu OUT

NOISE

POWER AMP Greater than 90 dB S/N ratio, unweighted.
MIXER Less than -90 dBu with master faders down -119 dBv equivalent input noise
COMMON MODE REJECTION RATIO Greater than 87 dB @ 1 kHz
CROSSTALK -65 dB @ 1 kHz

VOLTAGE AMPLIFICATION

74 dB \pm 2dB (maximum) @ 1 kHz MIC input to PA output
47 dB \pm 2db (maximum) @ 1 kHz MIC input to MAIN output
60 dB \pm 2dB (maximum) @ 1 kHz MIC input to EFX output
47 dB \pm 2dB (maximum) @ 1 kHz MIC input to AUX output
28 dB GRAPHIC EQ input to POWER AMP output

MAXIMUM INPUT LEVEL

LO-Z INPUT + 2.2 dBu (1.0 vrms)
HIGH-Z INPUT +22.2 dBu (10.0 vrms)

POWER OUTPUT

PX2008 2X150 watts into 4 ohms
PX2012 2X250 watts into 4 ohms

EQUALIZATION

INPUT LOW EQ \pm 15 dB @ 50 Hz, shelving
INPUT MID EQ \pm 15 dB @ 500 Hz, peaking
INPUT HIGH EQ \pm 15 dB @ 10 kHz, shelving
GRAPHIC EQ'S \pm 12 dB @ 63, 125, 250, 500, 1K, 2K, 4K, 8K, and 16 kHz

FADERS 60mm throw

INDICATORS

PEAK INDICATORS Each input channel, 3 dB below clip
Each power amp, at clipping point
VU LADDER DISPLAYS +6 VU = Rated power output into 4 ohms
PHANTOM POWER LED
POWER LED

INPUTS

Sensitivity and maximum input level are determined for 0 dBu at MAIN output with CHANNEL and MASTER fader at max. All other controls at 0 unless specified.

LO-Z Balanced (transformerless) 1.82k ohm actual impedance.
-46 dBu sensitivity (TRIM at MAX GAIN)
-33 dBu maximum input level (TRIM at MIN GAIN)
HI-Z Unbalanced 18.2k ohm actual impedance.
-26 dBu sensitivity (TRIM at MAX GAIN)
-13 dBu maximum input level (TRIM at MIN GAIN)

GAIN/LEVEL DIAGRAM

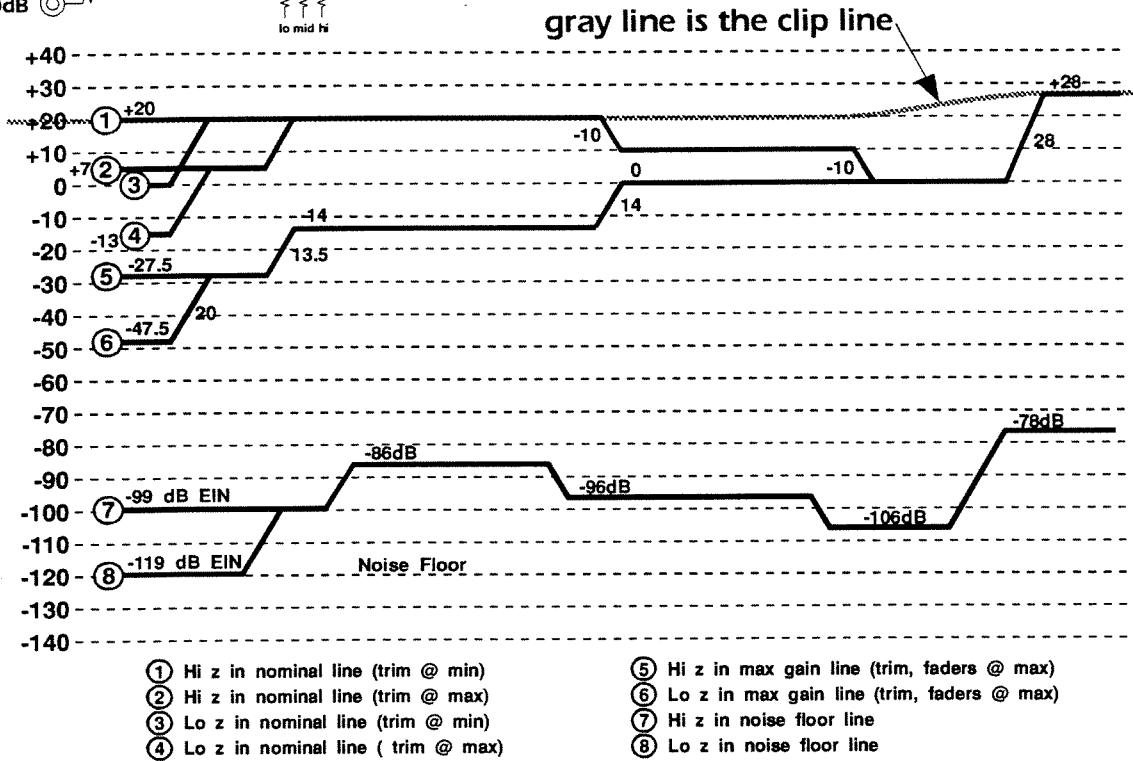
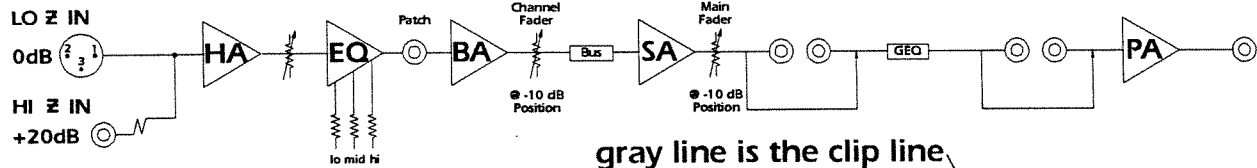

The following specs are measured with an input signal of 36 mV rms AC @ 1kHz applied to the LOW Z input of one channel. Nominal settings are with TRIM at MAXIMUM, CHANNEL EQ at 0 (flat), MONITOR, EFFECTS, and AUXILIARY SENDS at 5, CHANNEL FADER at 0 dB, MASTER FADERS at 0 dB, EFFECTS, AUXILIARY, and TAPE SENDS and RETURNS are set at 5.

OUTPUTS	Unbalanced, 150 ohm source impedance.
MAIN, MONITOR	0 dBu NOMINAL
EFFECTS	0dBu NOMINAL
TAPE	-1 dBu NOMINAL
AUX	-16 dBu NOMINAL
GRAPHIC EQ	0 dBu NOMINAL
ALL PATCH POINTS	Unbalanced, 150 ohm source impedance, +5.6 dBu NOMINAL LEVEL

MIXING BUSES MAIN, MONITOR, EFFECTS, AUX, TAPE

PHANTOM POWER +13 volts DC on pins 2 and 3 of each LOW-Z MIC input (pin 1 common)

REVERB Built in spring type unit, as well as provisions for external signal processing.

CONNECTORS

MIC, LINE INPUTS MIC: 3-pin female XLR (pin 2 high)
 LINE: TRS phone (tip=high, ring=low, sleeve=shield)
ALL OTHER CONNECTORS TS phone (tip=high, sleeve=low (shield))

POWER CONSUMPTION 120 volts (+-10%), 60 Hz. PX2008 900 WATTS. PX2012 1200 VA.

DIMENSIONS & WEIGHT	DEPTH:	23 1/2"	HEIGHT:	6"
	WIDTH:	PX2008 - 23 1/2"	WEIGHT:	PX2008 - 45lbs.
		PX2012 - 29 1/2"		PX2012 - 52lbs.

INPUT CHANNEL EQUALIZATION (TONE) CONTROLS

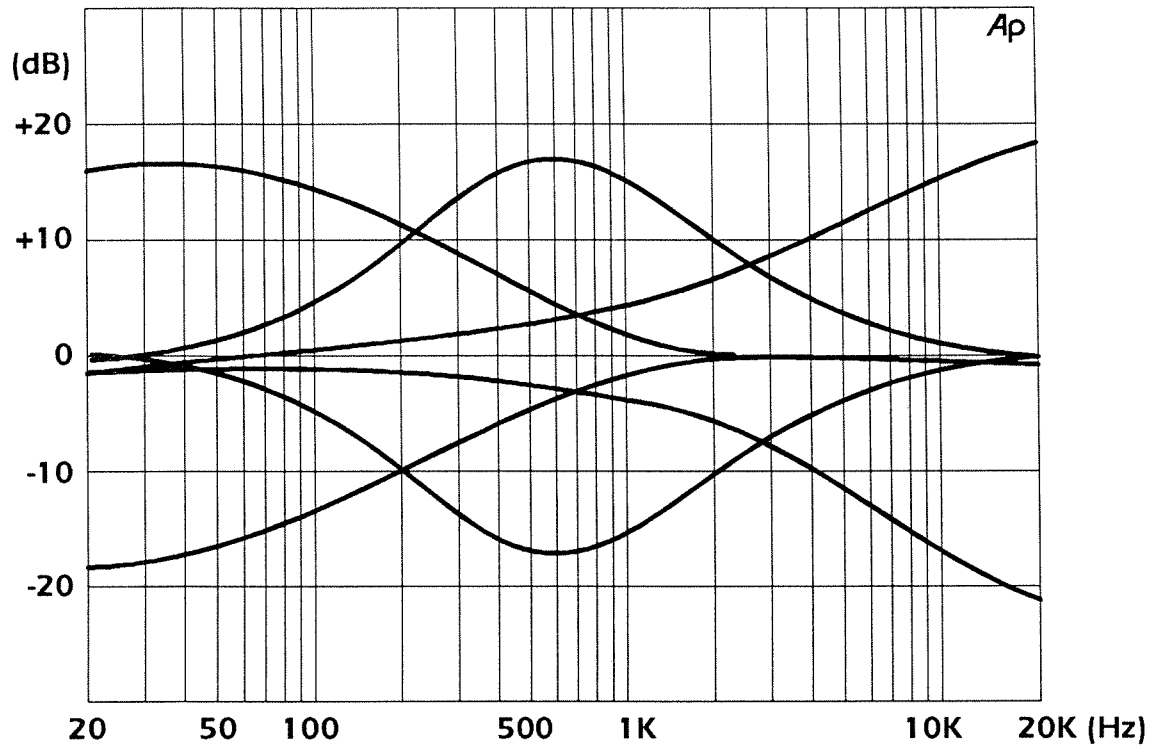

PROGRAM AND MONITOR GRAPHIC EQUALIZERS

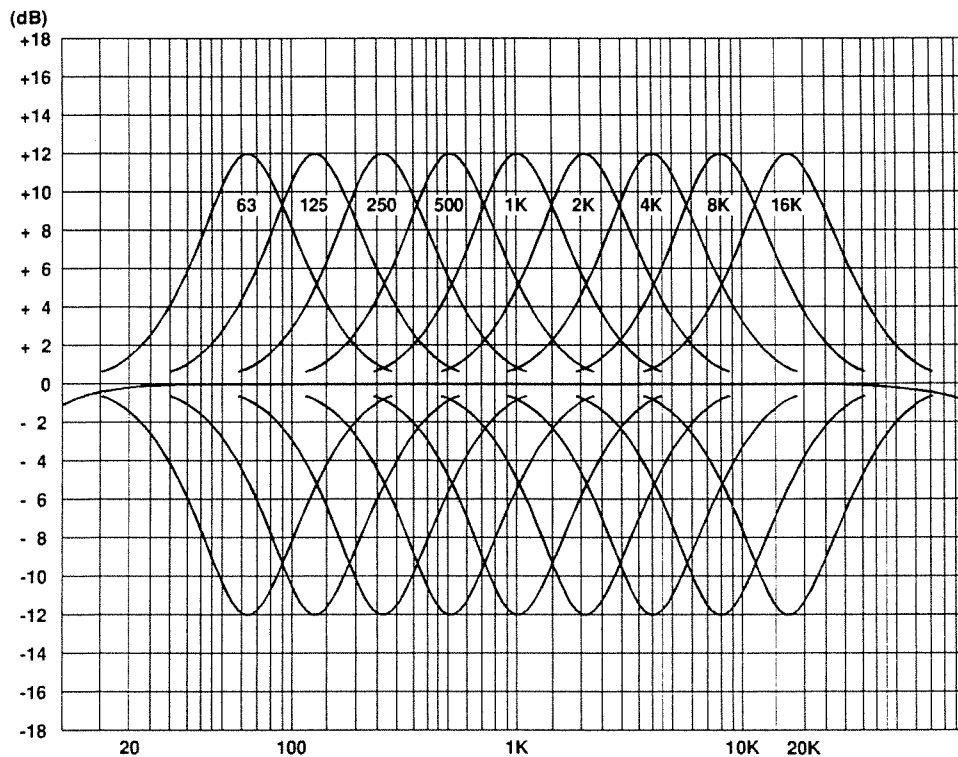

A PRODUCT OF:
FENDER MUSICAL INSTRUMENTS CORP.,
BREA, CALIFORNIA 92621