

SERVICE MANUAL



Sunn Musical Equipment Co. Amburn Industrial Park Tualatin, Oregon 97062

Beta series Amplifiers

MODELS

Beta Lead
Beta Bass
Beta Power Plus

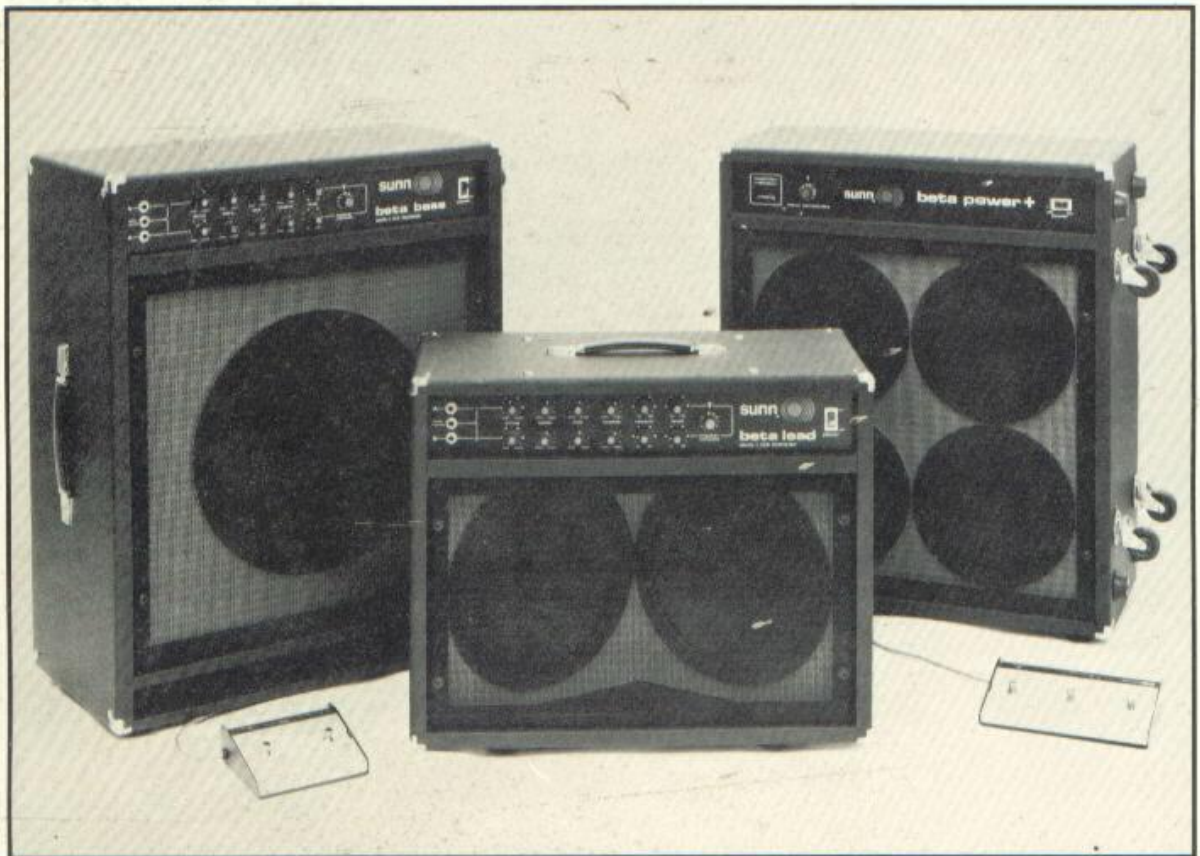

\$7.50

FOREWORD

This service manual is the result of the combined efforts of our engineering department, national authorized service centers, and the customer service staff.

You will find features not yet used in our industry, such as multi-colored circuit board layouts of components, both top and conductor views. To simplify and reduce troubleshooting time, you will find test points on the circuit board layouts that correspond to the schematics. You will also find parts lists and test specifications for simplified troubleshooting.

In order to keep your service manuals as current as possible, service bulletins will show the current modification, with parts variance, and page number in this manual affected by the change.

It is our sincere wish that our service manuals with this new format will become a valuable service tool and permanent addition to your service library.

CUSTOMER SERVICES STAFF

CUSTOMER SERVICE MANAGER

James A. Thomas

TECHNICAL SERVICE

Kerry Knauf

WARRANTY SERVICE

SECRETARY

Sandra Nearing

TABLE OF CONTENTS

Specifications	1
Sensitivity and Block Diagrams	2
Circuit Descriptions	3-6
Disassembly Procedure	7
Service Bulletins Important Notice	8
Beta Lead Preamp Schematic	9
Beta Lead Preamp Board Layout	10
Beta Bass Preamp Schematic	11
Beta Bass Preamp Board Layout	12
Beta Power Amp Schematic	13
Beta Power Amp Board Layout	14
Trouble Shooting Guide	15
Parts List	16

TYPICAL OPERATING SPECIFICATIONS

Beta Series

TEST EQUIPMENT USED

Scope	HP-1201A
Sine Generator	Heathkit, 1G-18
D.V.M.	Data Precision 1455
DB Meter	Simpson 314

TEST CONDITION

Line Voltage	120VAC
Voltage tolerances	10%
Signal	1 KHz
db tolerances	10%
Load	4 ohms

BETA LEAD & BASS

Preamp input Z (Channel A or B)	94K ohms
Both input Z	47K ohms
Channel A or B (Accessory From)	27K ohms
Channel A or B (Accessory To)	150 ohms
Master Accessory From (Poweramp input Z)	10K ohms
Master Accessory To	150 ohms

SYSTEM GAIN

Preamp in to Accessory output (Channel A or B)	80 db
Preamp Accessory input to Mater Accessory out (max)	10 db
Power Amp in to speaker out	30 db

TOTAL SYSTEM (maximum gain)

Channel A or B to speaker out	120 db
-------------------------------------	--------

DISTORTION

Total Harmonic Distortion (Power amp only)	less than .25%
--	----------------

POWER OUTPUT

100 watts
@ 4 ohms

WEIGHT

Beta Lead (amp top)	27 lbs
Beta Bass (amp top)	26 lbs
Beta 115	87 lbs
Beta 212	78 lbs
Beta 410	69 lbs

DIMENSIONS

	HEIGHT	LENGTH	DEPTH
Beta Lead & Bass (amp top)	6 $\frac{3}{4}$ "	x 24 $\frac{1}{2}$ "	x 10 $\frac{3}{4}$ "
Beta 115	31"	x 26"	x 13 $\frac{1}{2}$ "
Beta 212	21"	x 24"	x 11 $\frac{3}{4}$ "
Beta 410	29 $\frac{1}{2}$ "	x 26"	x 11 $\frac{3}{4}$ "

BETA LEAD, BASS OVERALL SENSITIVITY

Input	Control Settings	Output
460 MV P-P @ 1 KHz to preamp input	Drive control 5 Tone Controls mid Reverb effect 0 Level Control 5 Master Control 10	Preamp line out 1.1 V P-P Master line out 1.75 V P-P Speaker line out 56 V P-P with 4 ohm load

BETA PREAMP BLOCK DIAGRAM

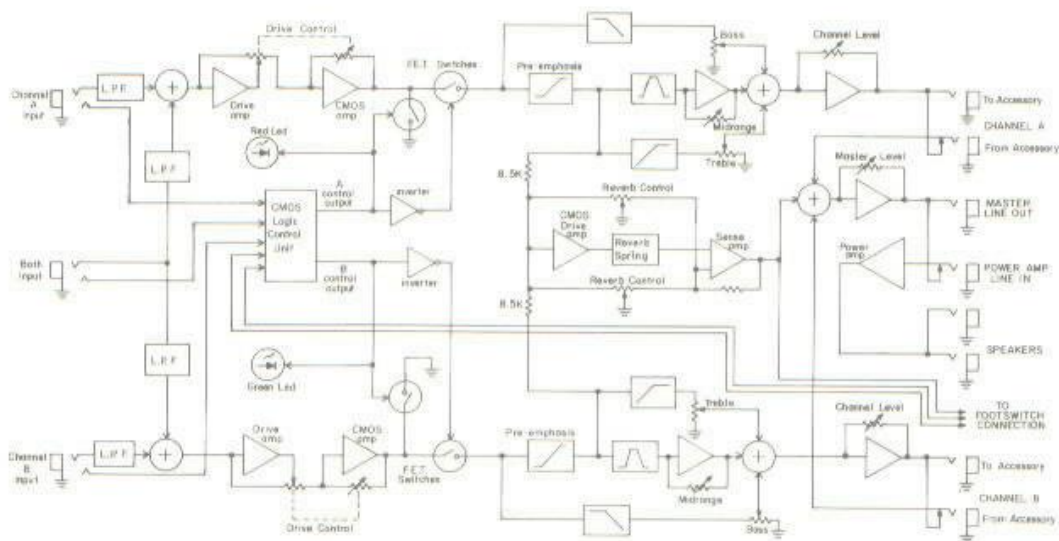

BETA POWER AMP BLOCK DIAGRAM

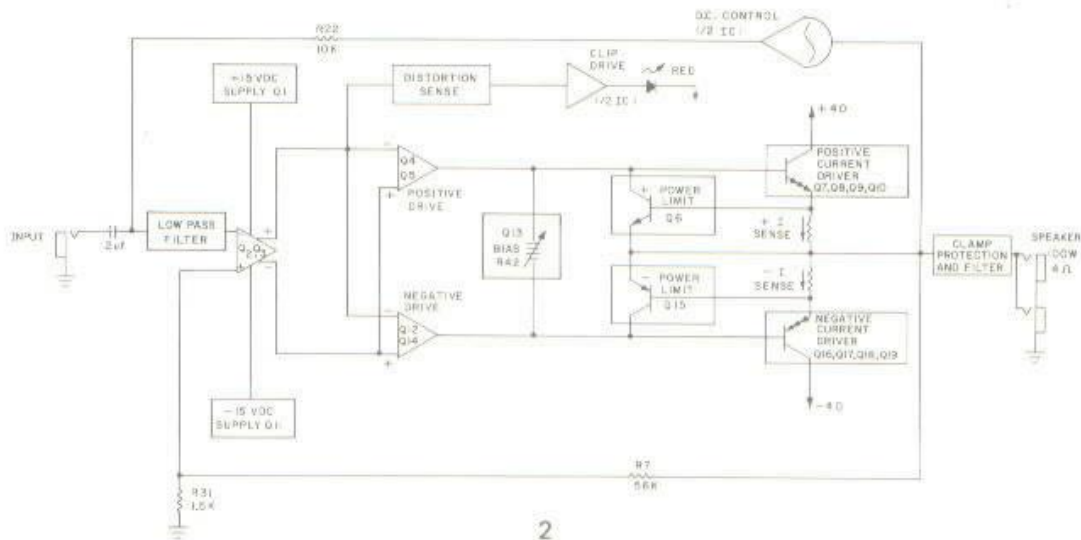

DRIVE SECTION

The drive sections of the Beta amplifiers consist of two I.C.'s, a dual op Amp and a 74C04 hex inverter. Looking at Channel "A" (channel A and B are identical) the signal from the input is amplified by both op amps of I.C.101. The gain of this stage is determined by half of the drive control, a dual ganged 1 meg ohm linear pot (R113). This pot, located between the two op amps of I.C.101 controls the amount of negative feedback to the first op amp and the input resistance of the second amp. This determines the amount of signal to pass this stage. The signal then passes through a high frequency emphasis circuit consisting of C105, R118, R117, and C106 to I.C.104. I.C.104 contains six inverting amps of which only four are used. The feedback circuit designed for this I.C. allows it to be used in a linear mode. The DC supply for this I.C. is +8 volts and ground. Since the C-mos tends to self bias at half the supply voltage, a DC level of about +4 volts will be found at the output of each amp.

The first three amps of I.C.104 can be thought of as one op amp. With the second half of the drive control (R127) between the first three amps of I.C.104 and the fourth amp, one can see that the gain of this stage is determined the same as with I.C.101. The use of C-mos in the Drive section of the Beta is for its soft limiting characteristics when over driven.

REVERB CIRCUIT DESCRIPTION

The reverb drive I.C. receives a signal from each channel through R205 (channel A) and R208 (channel B). These resistors with the reverb level pots, (R212 and R213) form a voltage divider network which determines the amount of signal that is delivered to the reverb drive amp. The reverb drive signal is buffered by one section of the C-mos reverb driver I.C.113. The output of this amp drives the other five amps of I.C.113, which are connected as a push pull amplifier. Both input terminals of the reverb pan are driven by a pair of amps connected in parallel through 100 ohm resistors (R221, R223, R224, R226). The remaining amp is used as an unity gain inverter to drive one pair of amps out of phase with the other amplifier pair.

As with the C-mos I.C.'s in the drive section of the preamp, I.C.113 is biased between +8 volts and ground. Therefore, a voltage of approximately +4 volts should be seen on the output of these amps.

The reverb sense amp, one half of I.C.112, receives the signal from the output terminal of the reverb pan. The gain of the sense amp is controlled by varying the feedback with the reverb level pots. The output signal from the sense amp goes through R232 and C156 to the footswitch connectors and from there to the master mixing stage through R233.

LOGIC CONTROL CIRCUIT

The control system in the Beta amplifiers is an array of digital C-mos gates which drive F.E.T. two-phase switches and also drive two front panel led indicators. The control system decides which channel or channels are to be "on" based on two types of information. The first of these is the presence or absence of a phone plug in the input jacks on the front panel. The input jacks on the Beta Series amplifiers are actually stereo-type jacks. When an ordinary phone plug is inserted into one of these jacks it grounds the second contact of that jack which is sensed by the C-mos logic. The second type of control system input is derived from the footswitch unit (optional accessory) through the lines labeled "P" & "S" on the schematic.

The switching functions of the Beta are implemented by two C-mos digital integrated circuits. The first is a MC14506 BCP Dual Expandable And Or Invert gate (I.C.106) and a 74C04 Hex Inverter (I.C.103). The operation of these I.C.'s is based on the logic level at the inputs, -15 volts to -9 volts is considered a low state or "0", -6 volts to ground is considered a high state or "1".

Looking at Channel "A". (Channel A and B are identical.)

When Channel A input jack is open (no phone plug inserted) a low state will be sensed by I.C.106. A low state will appear at the output of I.C.106, (pin 15) causing Q101 to be off. Therefore, no current flows through the led and it is off. The line going to the gate of Q103 is at approximately "0" volts (ground) which causes that F.E.T. to be on and to shunt out any signal or noise coming through R130. At the same time the "0" volt level going to the gate of Q103 goes to pin "1" of I.C.103 and is inverted to a level of about -14 volts at the output of pin 2. This voltage is applied to the gate of the second F.E.T. Q104, which turns this F.E.T. off. This greatly attenuates any signal which may have gotten past Q103.

When a plug is inserted into Channel A, a high state will be sensed by I.C.106 and a high state will appear at Channel A control output (pin 15 of I.C.106). This will turn on Q101 which allows current through the Channel indicator (a red led). The voltage at the collector of Q101 will go to about -14 volts. This will turn off Q103, and through the inverter turn on Q104. This will allow the signal to flow into I.C.107.

TONE CONTROL EQUALIZATION CIRCUIT

Since both channels are identical, only Channel "A" will be described.

The signal from the F.E.T. switches is amplified and buffered by one half of I.C.107. The output from this amplifier drives the low frequency filter directly. It also drives a high frequency pre-emphasis network which in turn drives the midrange and treble filters.

The low frequency filter is a single pole, low pass network formed by R194, C139, and R195. R196 is the low frequency mix resistor which sets the maximum low frequency gain. From R196 the signal goes through the bass pot and to the channel mixer.

The high frequency pre-emphasis network consist of C138, R182, and R183. This network provides a high frequency boost starting at about 1KHZ and rising to a maximum of +10db at about 10KHZ. The pre-emphasized signal is buffered by the second half of I.C.107 and is used to drive the midrange and high frequency filters.

The high frequency filter is also a single pole network as in the bass filter, consisting of C143 and R191. R192 is the high frequency mix resistor.

The midrange filter is a bandpass using a gyrator-type circuit made up of one half of I.C.109. The mid pot (R193) controls the Q of the mid range filter circuit and also the gain of the buffer amp, the second half of I.C.109. The output of the midrange filter is mixed into the next stage through R190.

FOOTSWITCH CIRCUIT

The Beta Series footswitch contains no active circuitry. Instead, the voltage drop across the leds is used to actuate the switching functions. The A-B channel switching is controlled by the voltage on the "S" line from the footswitch. When the switch is closed, current flows through the green led and R138 to the -15 volt supply. This places a voltage of approximately -2 volts at the "S" terminal. This voltage is sensed as a "1" by the logic control. If the switch is open, current can no longer flow through the green led, so the voltage at the "S" terminal goes up until the red led turns on. The current now flowing through the red led, R3, CR4, CR5, and R138 causes a voltage of approximately -9 volts to be sensed at the "S" terminal. This voltage is sensed as a "0" by the logic control.

The opening and closing of the Both switch will have similar effect on the "P" line. With the switch open a voltage of about -9.5 volts "0" will be sensed by the logic control circuit at "p". When the switch is closed, current flows through the led, turning it on and through R1, R2 and R136 to the -15 volt supply placing about -5 volts at "P" which is sensed as a "1" by the logic control circuit.

POWER AMPLIFIER CIRCUIT DESCRIPTION

Power Output Stage

The action of the output stage is identical for positive and negative swings. For simplicity, we can look at positive excursions of the output. As Q_4 increases current, it provides base drive for Q_5 . Q_5 sees a voltage gain from emitter to collector and applies base drive to Q_7 . Q_7 is the first stage in a series of emitter coupled current gain elements. Q_7 increases the base drive to Q_8 which provides the base drive for both Q_9 and Q_{10} . There is approximately unity gain from the base of Q_7 to the output. Q_9 and Q_{10} provide the major load current on positive excursions. Similarly, Q_{18} and Q_{19} provide the current on negative excursions. Removal of Q_7 and Q_{16} may provide easy identification of a malfunction from driver or output stages.

Power Limiting

The action of the positive and negative power limiting circuitry is identical. Looking at the positive case, the average current is sensed in Q_9 and Q_{10} by comparing the voltage at the common output line versus the voltage at the junction of R_{19} and R_{20} . Thus, the mean of the two currents is sensed and applied as base drive to Q_6 during high current conditions. When the output is near zero volts, R_{14} applies .25V bias to Q_6 to enhance the current limiting during short circuit conditions. CR_3 and R_{15} rob the base drive for Q_6 during positive excursions so that peak currents are not limited but rather a power limiting function for the output transistors is approximated. When Q_6 or Q_{15} are active they defeat the base drive to the output stage and provide protection for the output transistors.

Bias Adjustment

Q_{13} is used to set the Class A-B bias current in the output stages. It is used as a V_{be} multiplier, which is adjusted by R_{42} . Hence, the D.C. collector-emitter voltage which varies the standing current in the output devices, is adjusted by R_{42} . This voltage is a function of the base-emitter junction condition which is temperature dependent. By heat-sinking Q_{13} to the output devices, the variance of bias current with temperatures, is reduced.

The amplifier must be at room temperature, with no signal applied. Adjust R_{42} for a DC voltage reading of 1MV across R_{18} after the unit has been on for a period of ten seconds. Then check for crossover distortion by applying a 1KHz signal to the power amplifier input and looking at the output signal (1V P-P) across a 4 ohm load. There should be no crossover distortion present.

Overall D.C. control is provided by 1/2 of the integrated circuit package. Zero D.C. average output voltage is achieved by integration of the output signal and application of an error correction voltage through R_{22} . R_{45} is used to null the offset current so that the output voltage remains within the offset voltage range of the I.C. op amp.

The clipping light is triggered by sensing the distortion within the amplifier's loop. Whenever clipping occurs, or a short circuit condition, or any phenomena that defeat the amplifier's ability to reproduce the input signal, a larger signal voltage will be seen on the collector of Q_3 . When this signal is greater than $\pm 6V$, it is sensed by the integrated operations amplifier. Normally, the amplifier is biased so that its output is at $-12V$. However, if the signal applied through R_{32} is great enough to cause CR_6 to conduct current and bring the potential at pin 2 of ICI below that of pin 3, the amplifier's output will go positive and light the clipping indicator. Similarly, if CR_7 conducts during a positive excursion of the collector voltage of Q_3 , it will raise that potential of pin 3 above that of pin 2 and again light the clipping indicator.

DISASSEMBLY PROCEDURE FOR THE BETA SERIES AMPLIFIER

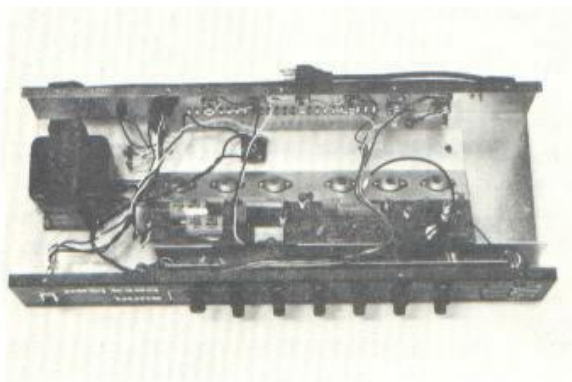

Power Amplifier Servicing – Diagram One

1. Remove four screws on the top of cabinet. If unit is a self-contained cabinet remove speaker jump cable between cabinet and chassis.
2. Remove amplifier from cabinet.
3. Remove outer chassis wrap and set amplifier on its top with controls toward you. Power amplifier is now ready for servicing.

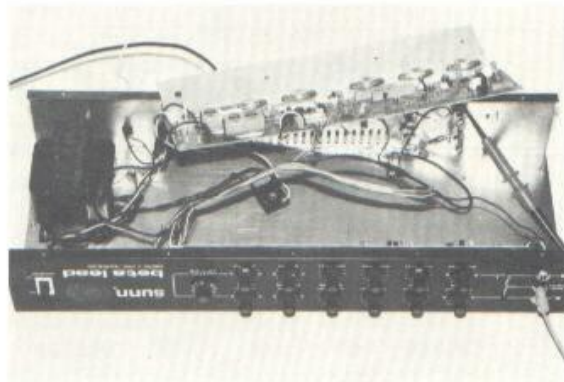

Pre-amp Servicing – Diagram Two

1. Perform steps 1-3 in power amplifier servicing.
2. Remove preamp shield (four screws).
3. Disconnect 8 pin molex connector at power board.
4. Disconnect power supply from power board.
5. Remove four screws that are holding power board to chassis and remove power board.
6. Mount power board to the top edge of chassis with one of the screws used to hold chassis wrap to chassis. Use existing hole for mounting. (See diagram 2.)
7. Reconnect molex connector and power supply to power board.

Preamp is now accessible for servicing.

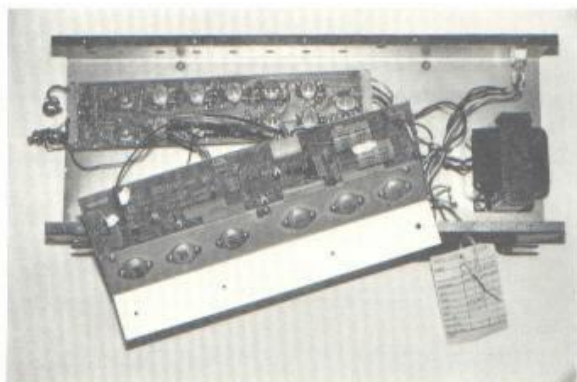

Pre-amp Disassembly – Diagram Three

1. Remove all knobs from front panel.
2. Remove all mounting nuts holding controls and input jacks to front panel.

Preamp can now be removed from front panel for component replacement.

Reassembly Procedure

Reverse all steps used in disassembly procedure. Be sure that the lock washers are on all controls and input jack and mounting nuts are securely tightened. Carefully tuck wiring harness between chassis and front panel as shown in diagram 1. Check to make sure that the wiring harness crosses the preamp shield where the shield has been covered with a protecting tape (see diagram 1).

IMPORTANT NOTICE

Modifications have been made as part of SUNN's on going product improvement program. Because these modifications do not affect product reliability, they are not covered by the SUNN Limited Warranty Policy. Any product updating to new specifications are not subject for payment by SUNN.

1. Refer to Service Bulletin #38 indicating a change in the level control circuit. This affects all Beta Series amplifiers with a serial number less than A-31084.
2. A change in the Beta amplifiers involves changing from 1/2 watt resistor layout to 1/4 watt resistor layout on the preamp board.
3. Beta Lead amplifiers from serial number A-52175, Beta Bass amplifiers from serial number A-49915 and Beta Power + amplifiers from serial number A-39937 is a change of resistors values (R16 and R46) on the power board. All units before the given serial number will have a 120 ohm resistor installed. All units with serial numbers after the given serial numbers will have 560 ohm resistors installed.
4. The Beta preamps have had two resistors and two capacitors added to the channel switching circuit. All units with a serial number after A-52175 (Beta Lead) and A-49915 (Beta Bass) will have a 2.2uf capacitor added across pins 1 and 2 and across pins 5 and 6 of I.C.103. The resistors added (100K ohm 1/4 watt) are place between the collector of Q101 and pin 1 (I.C.103) and between the collector of Q103 and pin 5 (I.C.103).
5. The Beta Lead reverb circuit has had four resistor value changes. All units with a serial number before A-52175 have 10K ohm resistors at R222 and R225, they have a 100K ohm resistor at R211 and a 27K ohm at R233. All units with a serial number after A-52175 have a 22K resistor at R222 and R225. They also have a 1 meg ohm resistor at R211 and a 100K ohm resistor at R233.

The preamp and power amp schematics are up to date with what is now being installed on the circuit boards. The board layout does not show the location of R237 and R238, C164 and C165. With the schematic and the existing board layouts, one can easily find the location of these parts. The placement of the rectifer has been moved from its location on the power board layout. See Service Bulletin #39 for installation of the rectifier.

SERVICE NOTES

Beta Lead Component Side

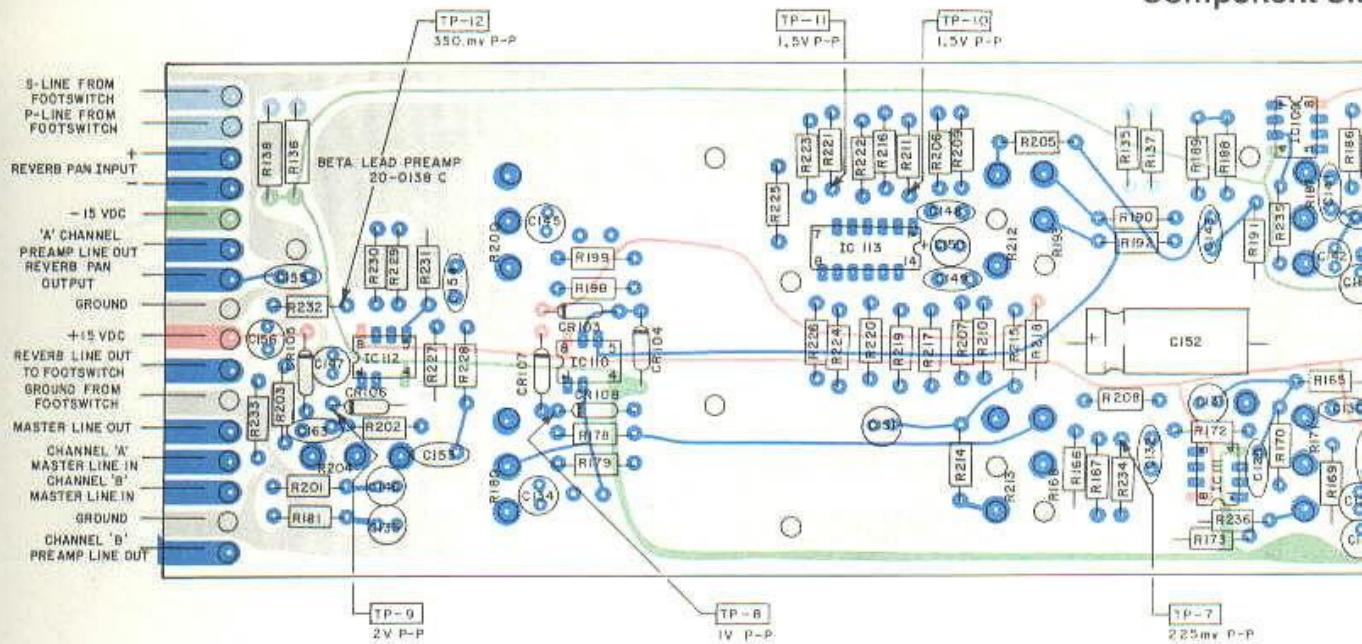

Beta Lead Solder Side

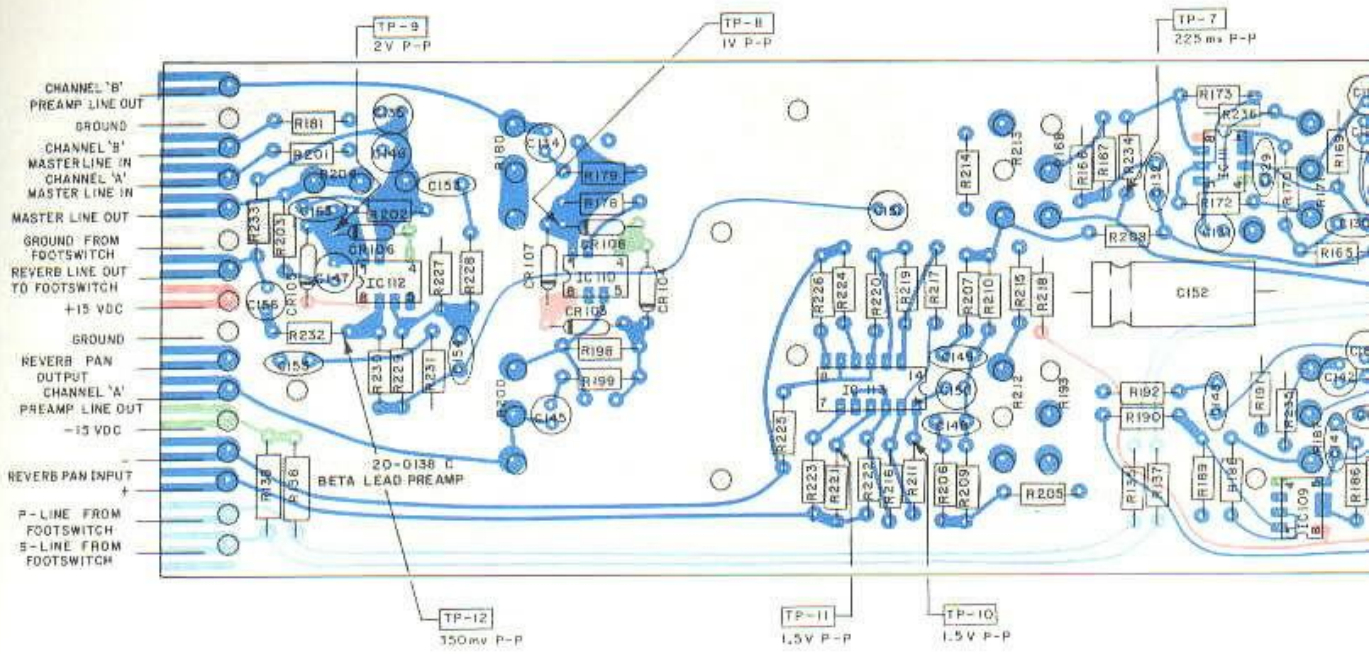

Beta Lead

Component Side



Beta Lead

Solder Side

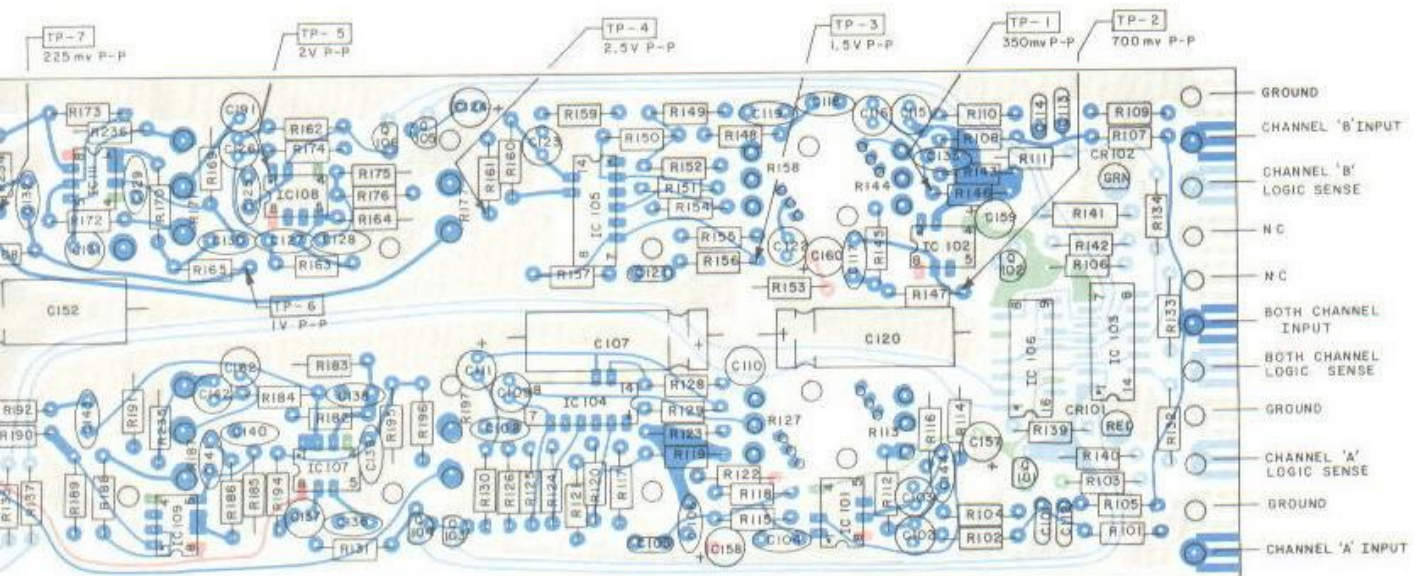

- +40 vdc - Red
- +15 vdc - Medium Red
- +8 vdc - Light Red
- 40 vdc - Green
- 15 vdc - Medium Green
- Signal - Blue
- Logic Control Circuit - Medium Blue
- Ground - Light Gray
- Component - Black

- SEMICONDUCTORS
 217, Q102
 Q103, Q104, Q105, Q106
 100, 101, 102, 103, 104, 105
 112, 113, 114, 115, 116, 117, 118, 119, 120, 121, 122, 123, 124, 125
 106

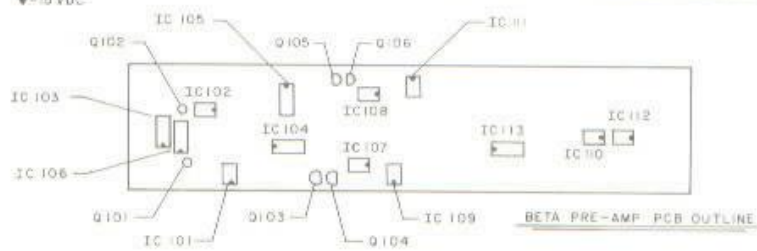
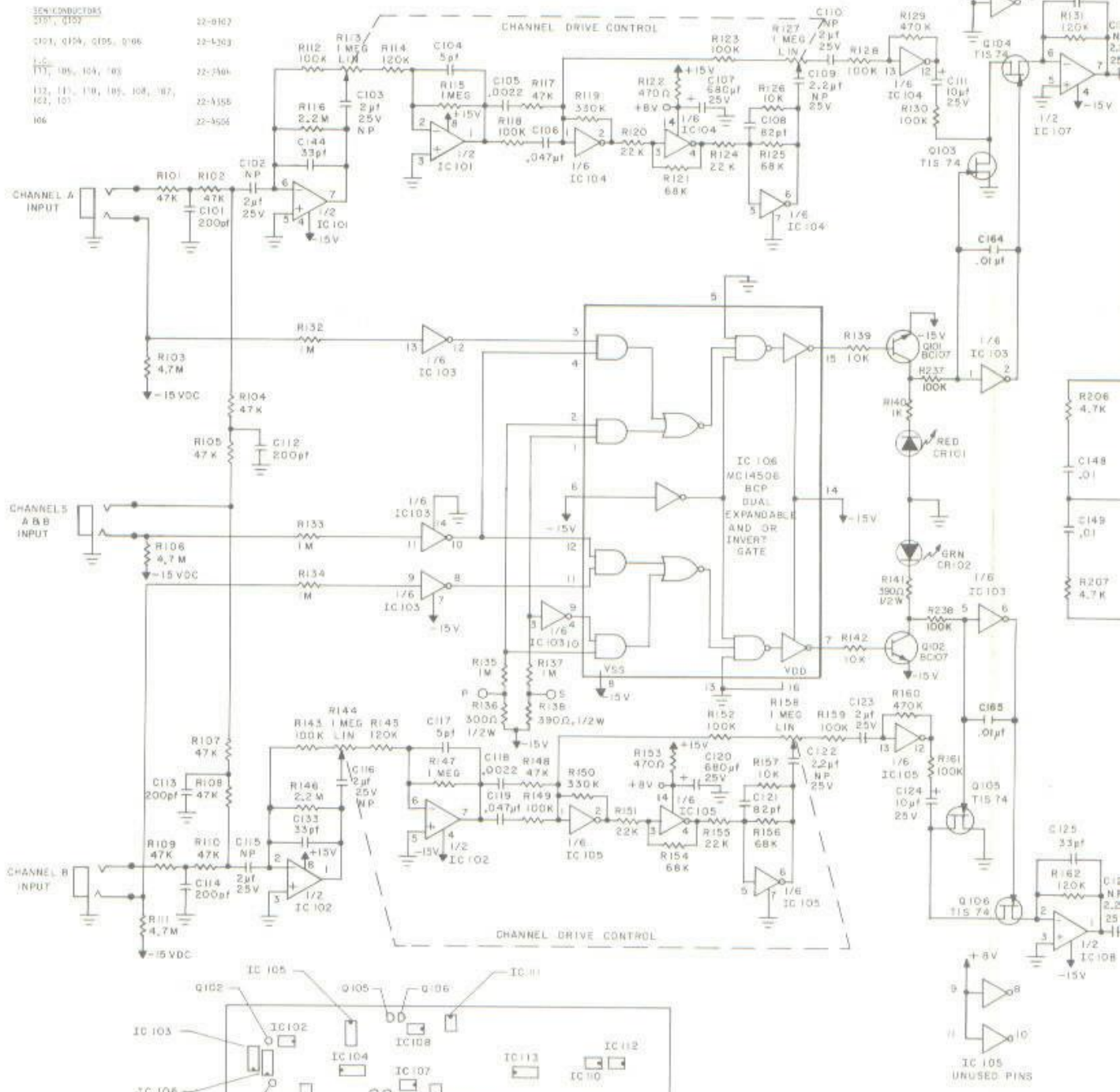

AD PREAMP SCHEMATIC

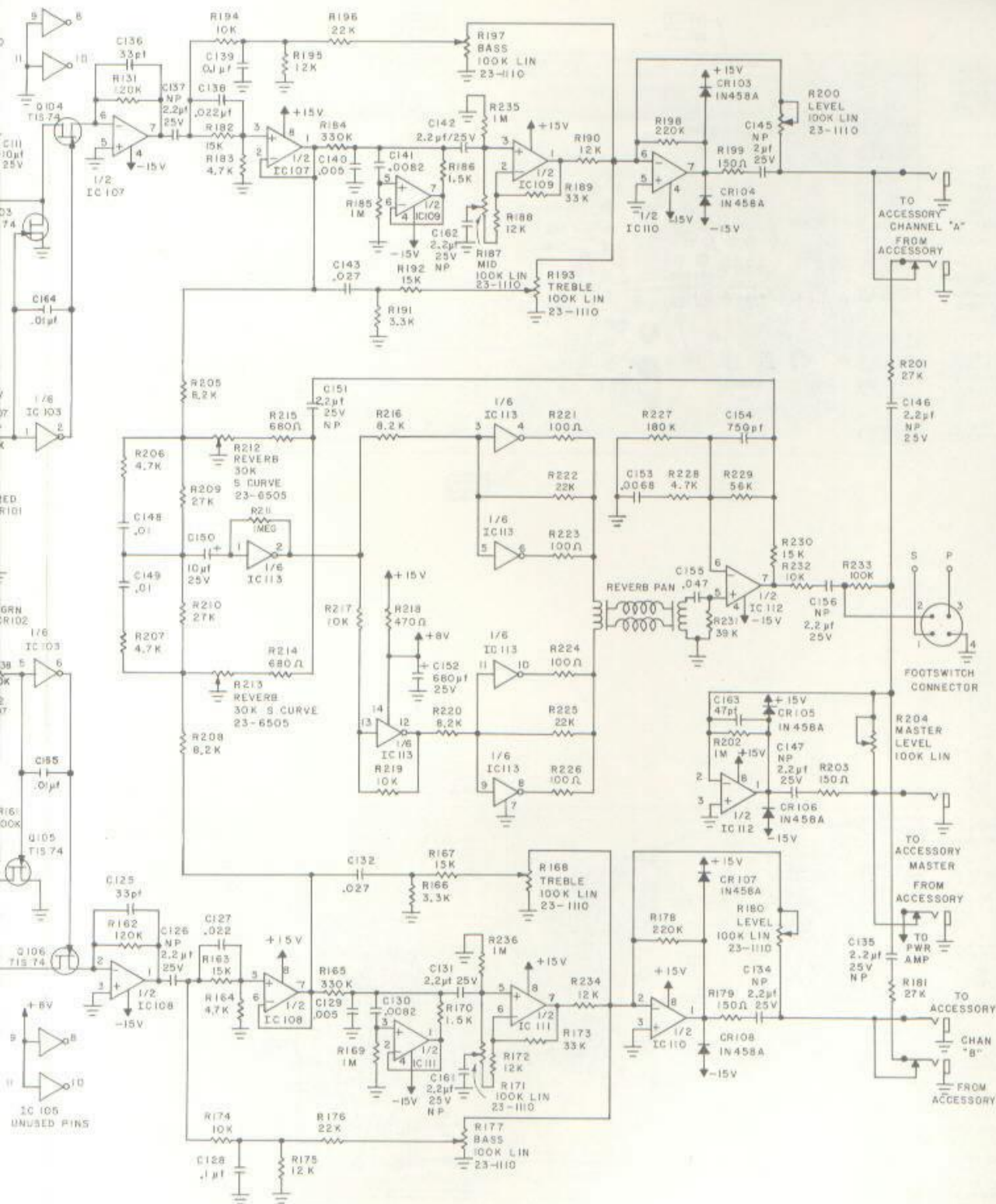

Beta B
Compon



Beta B
Solder S

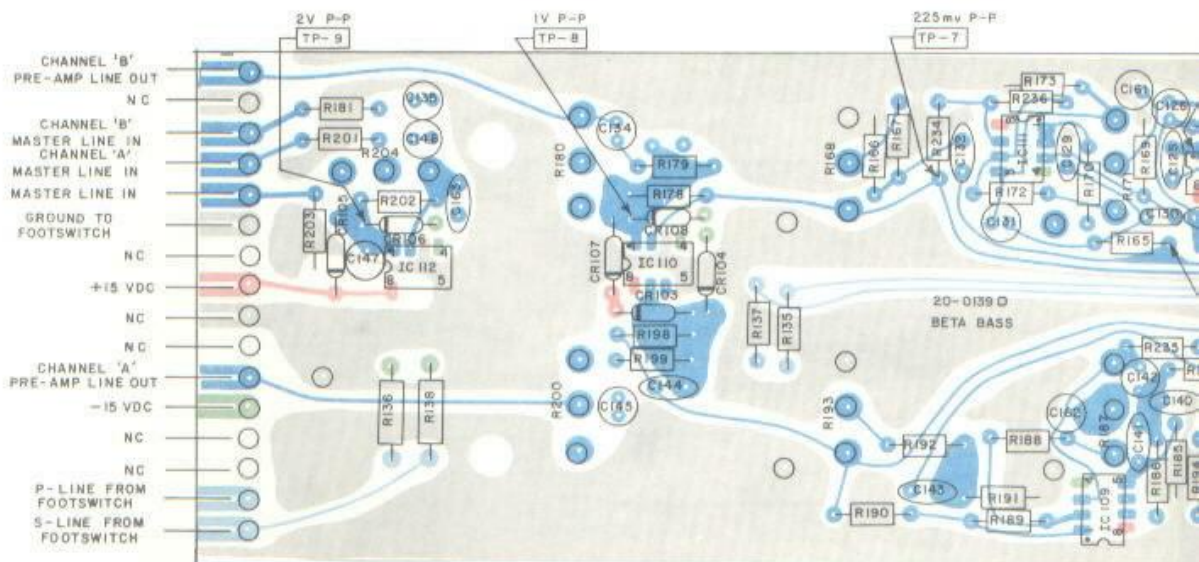

Beta Bass

Component Side



Beta Bass

Solder Side

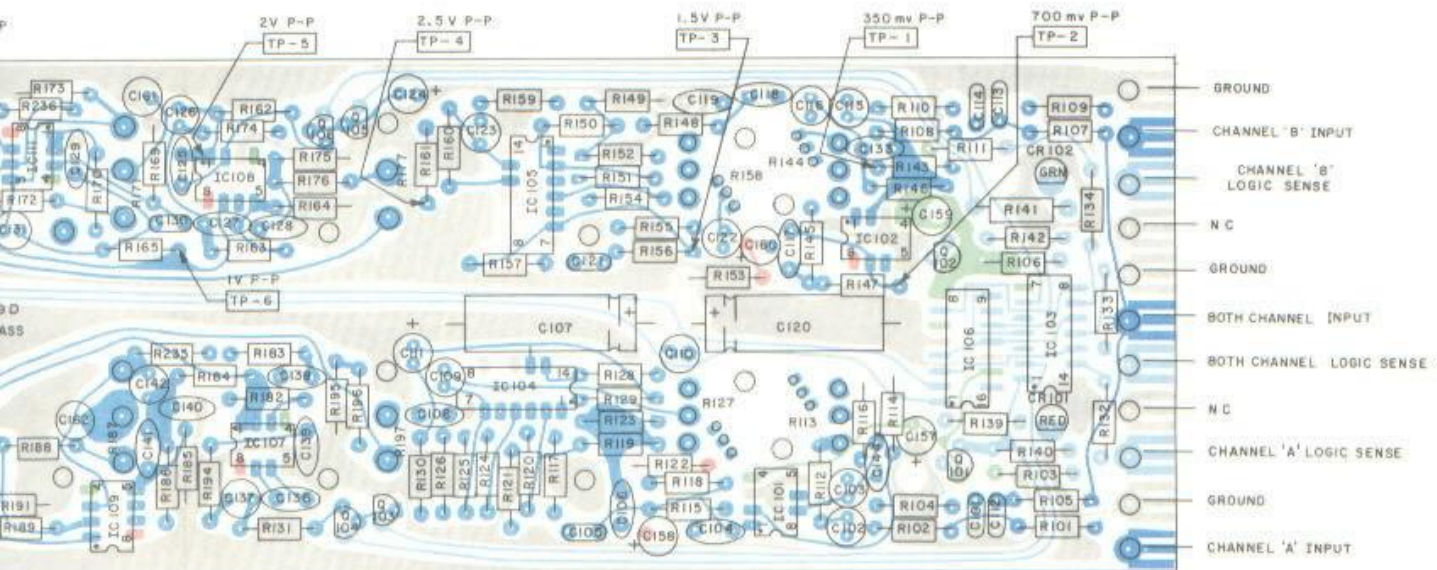

- +40 vdc — Red
- +15 vdc — Medium Red
- +8 vdc — Light Red
- 40 vdc — Green
- 15 vdc — Medium Green
- Signal — Blue
- Logic Control Circuit — Medium Blue
- Ground — Light Gray
- Component — Black

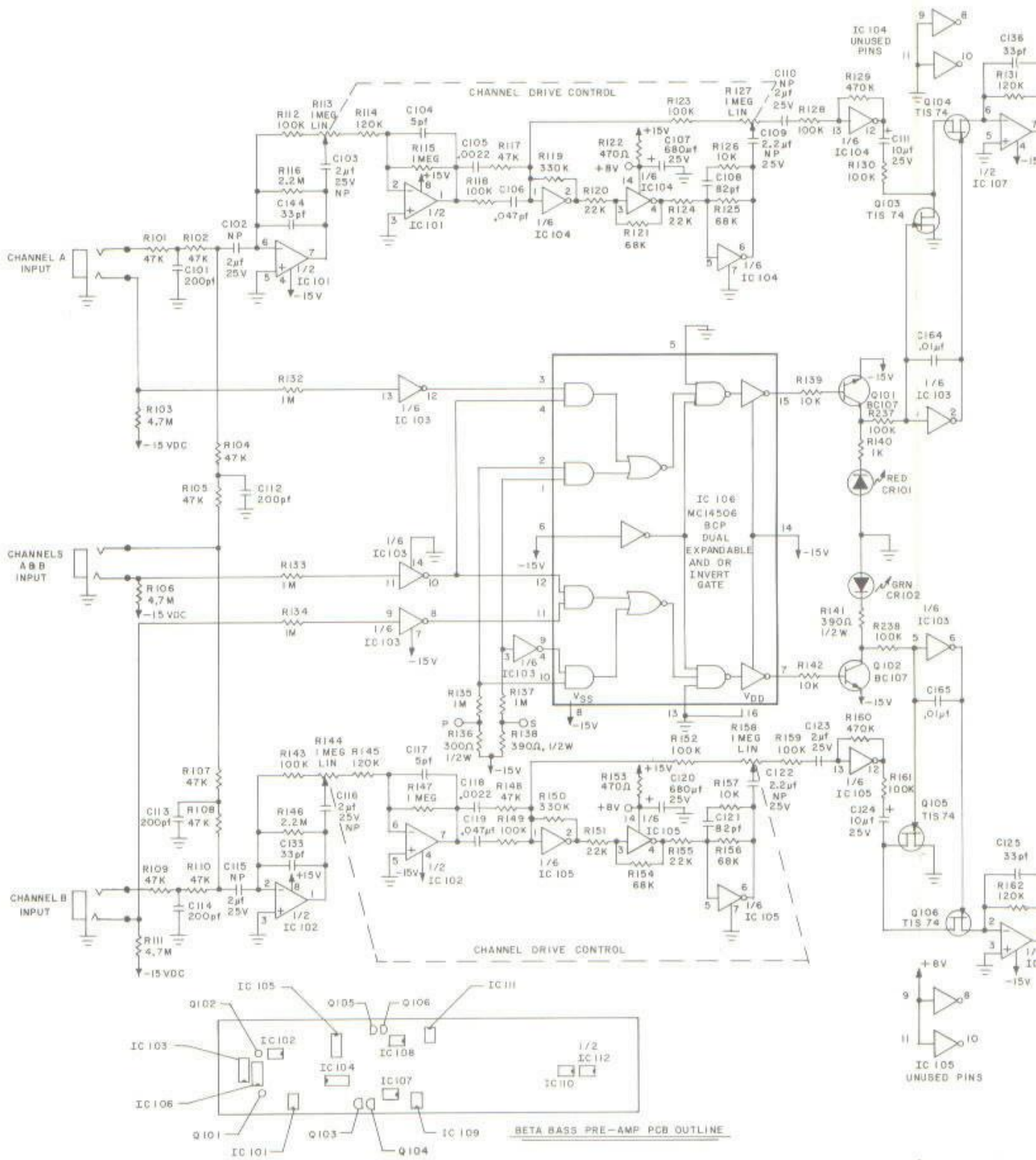

SS PREAMP SCHEMATIC

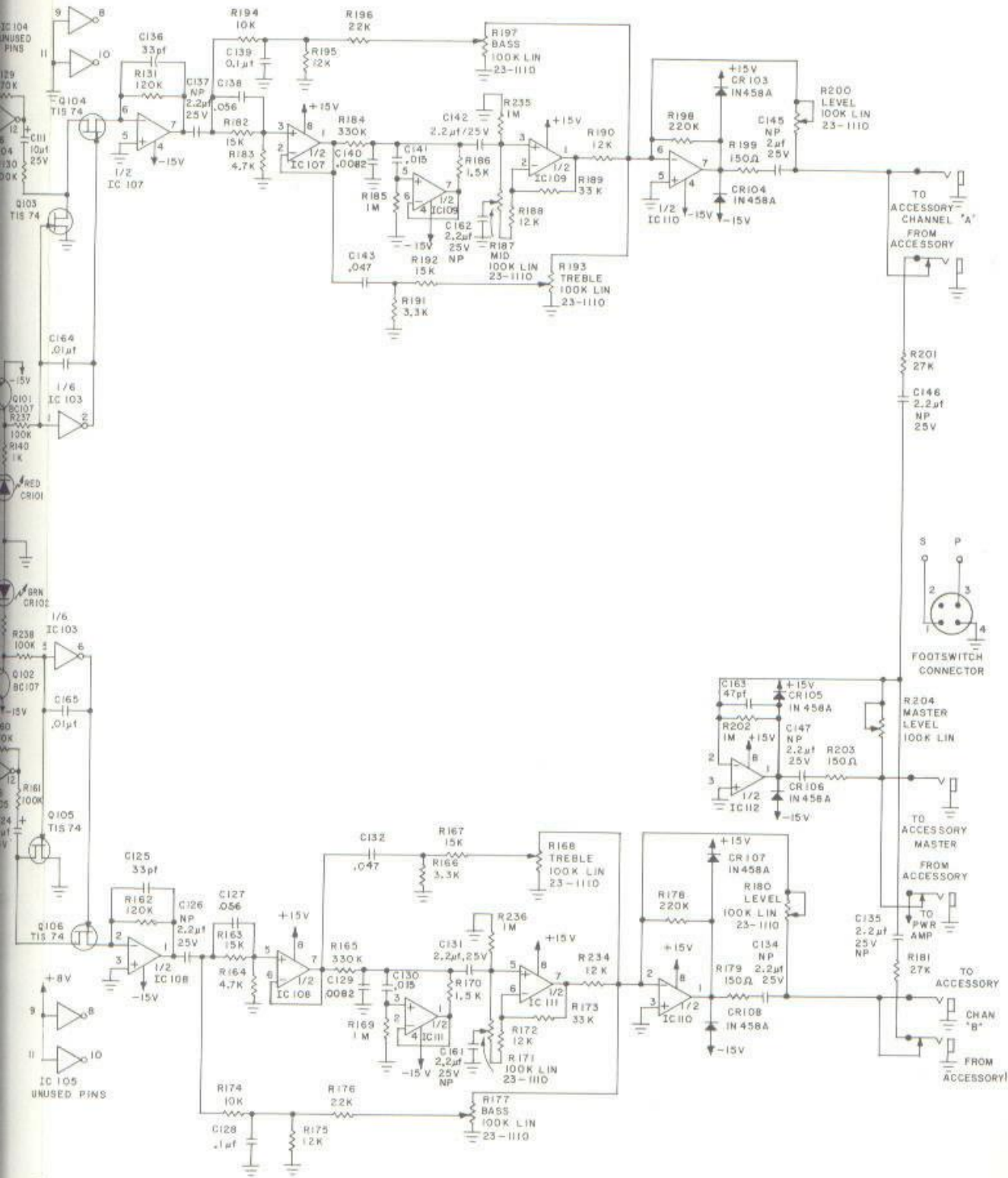

Beta Series Power Board

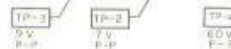
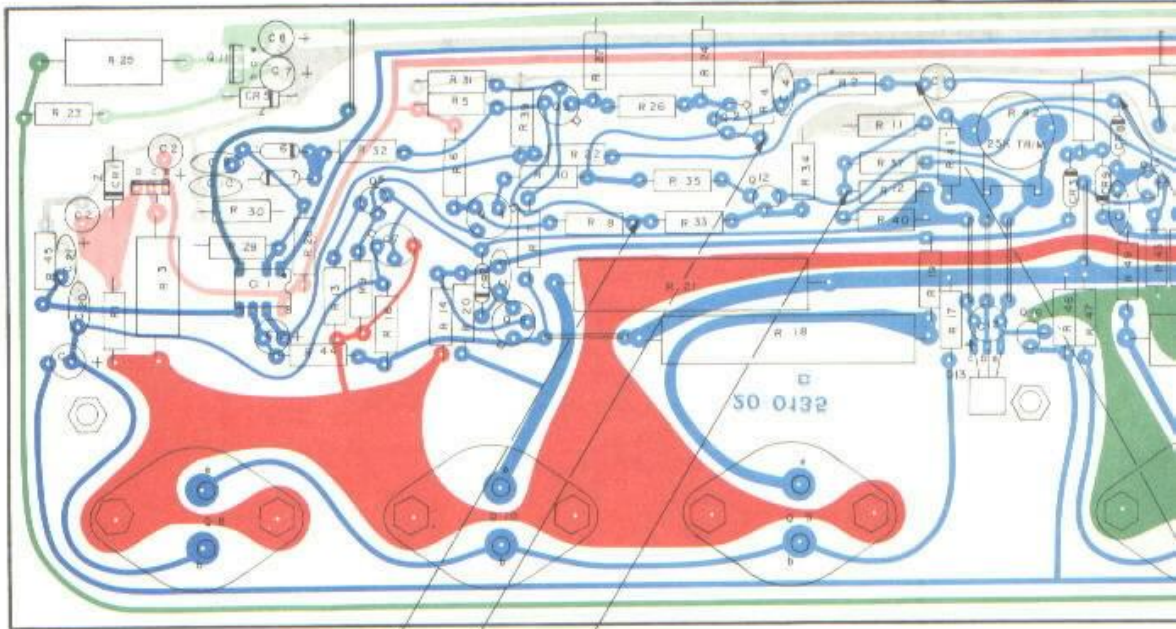

Component Side

Solder Side

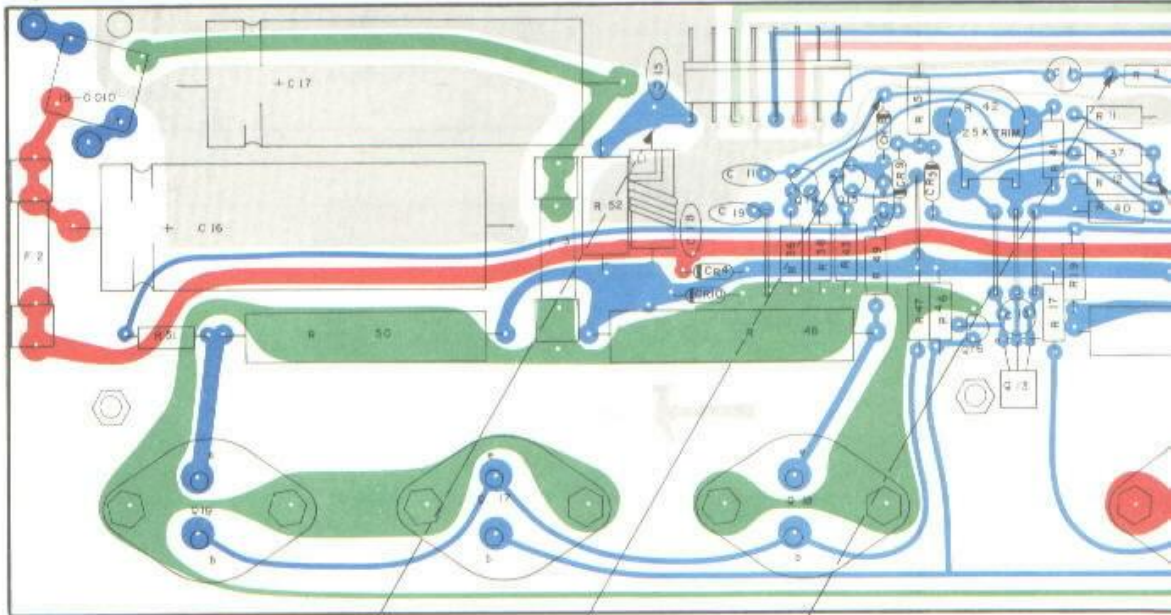

Series Power Board

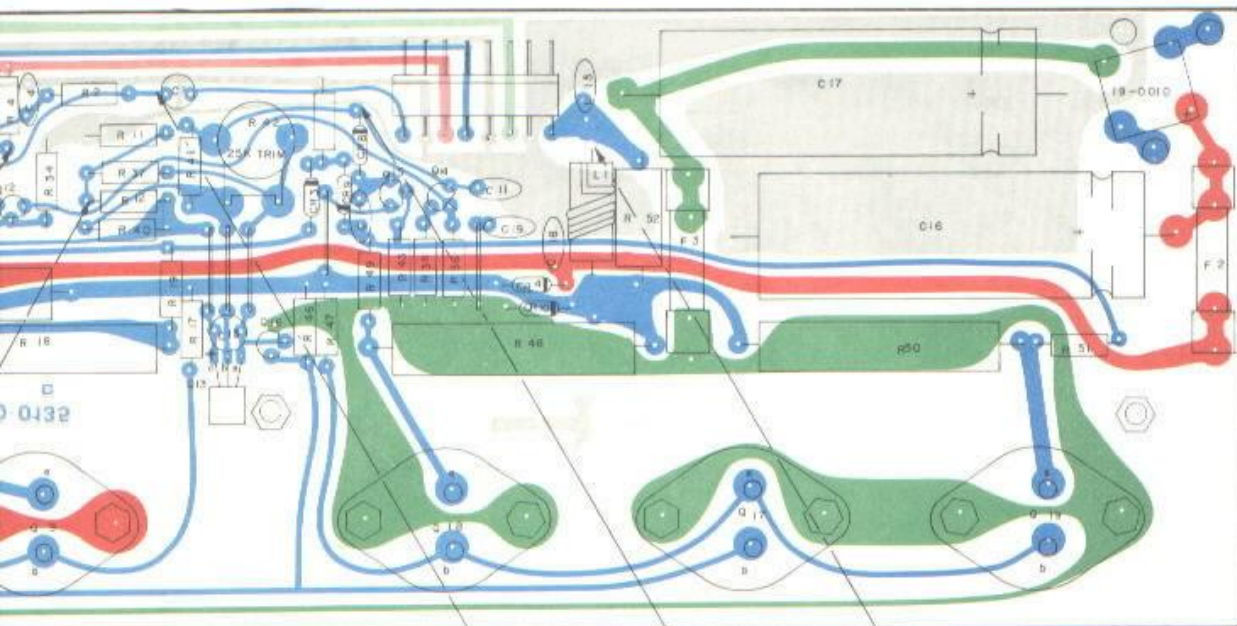

TP-1
2.2V
P-P

TP-5
60V
P-P

TP-6
60V
P-P

+40 vdc	Red
+15 vdc	Medium Red
+8 vdc	Light Red
-40 vdc	Green
-15 vdc	Medium Green
Signal	Blue
Logic Control Circuit	Medium Blue
Ground	Light Gray
Component	Black

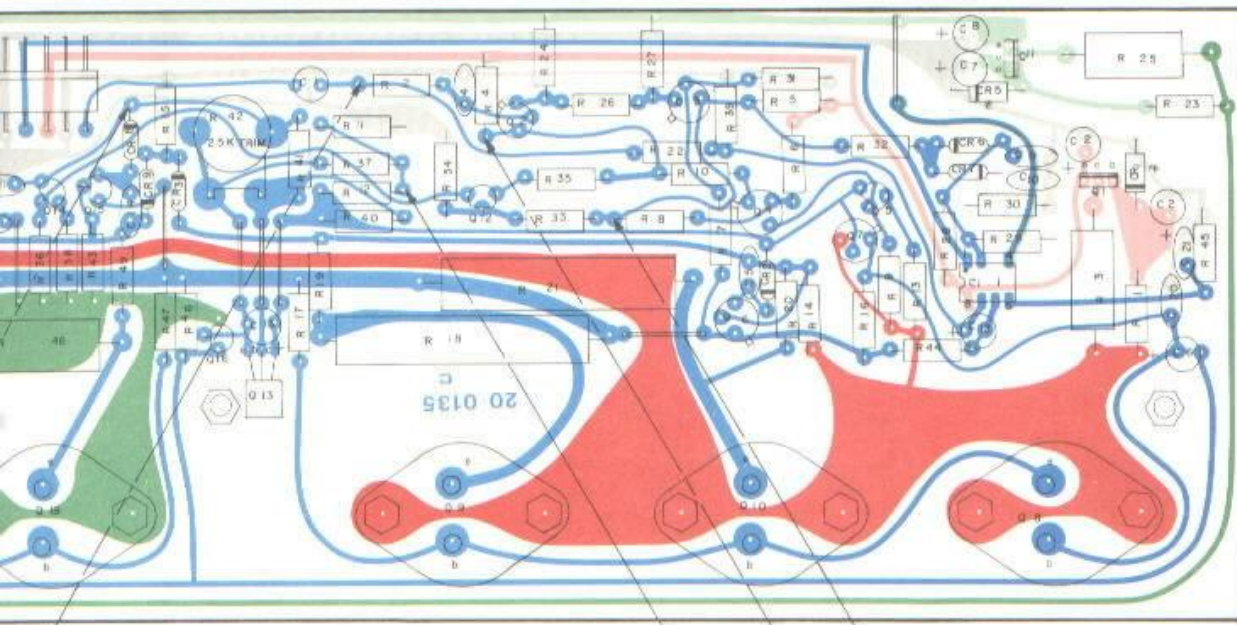

TP-4
50V
P-P

TP-2
7V
P-P

TP-3
5V
P-P

BETA POWER AMP SCHEMATIC

BETA SWITCH III

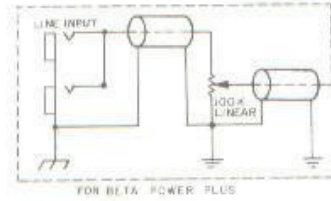
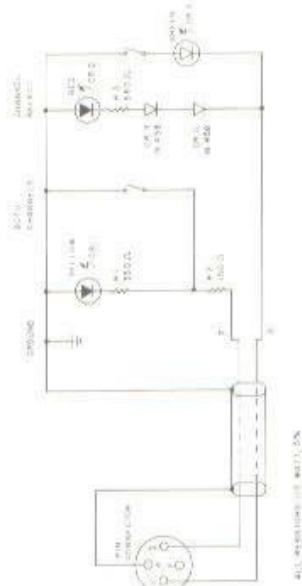

BETA SWITCH II

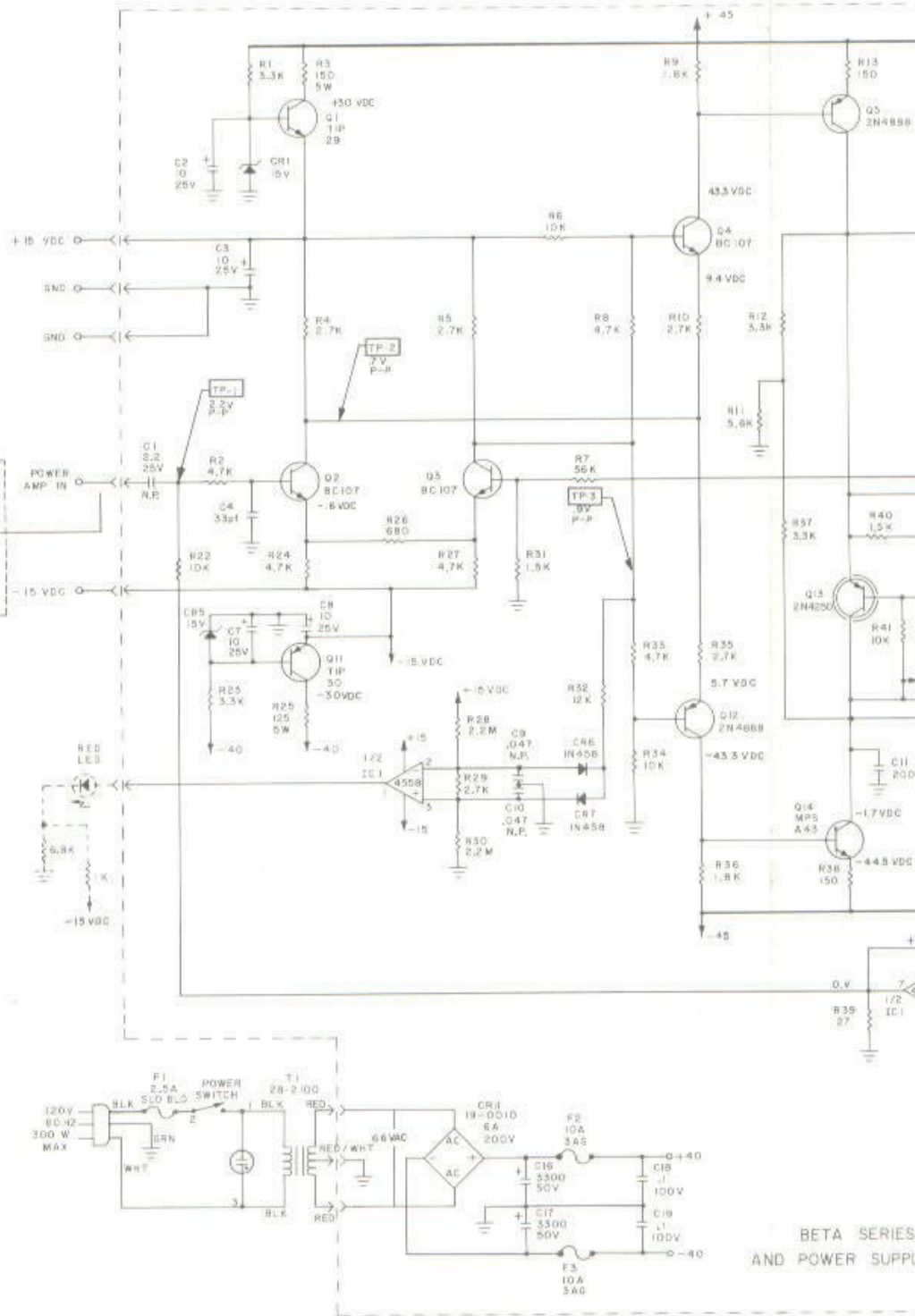
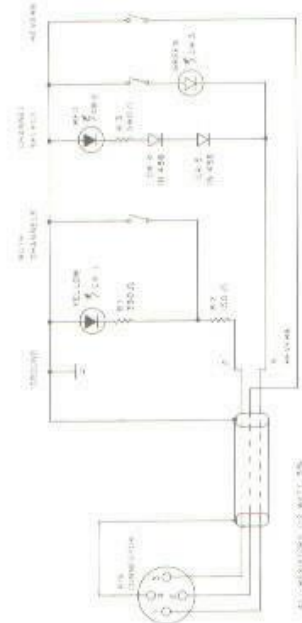

POWER AMP SCHEMATIC

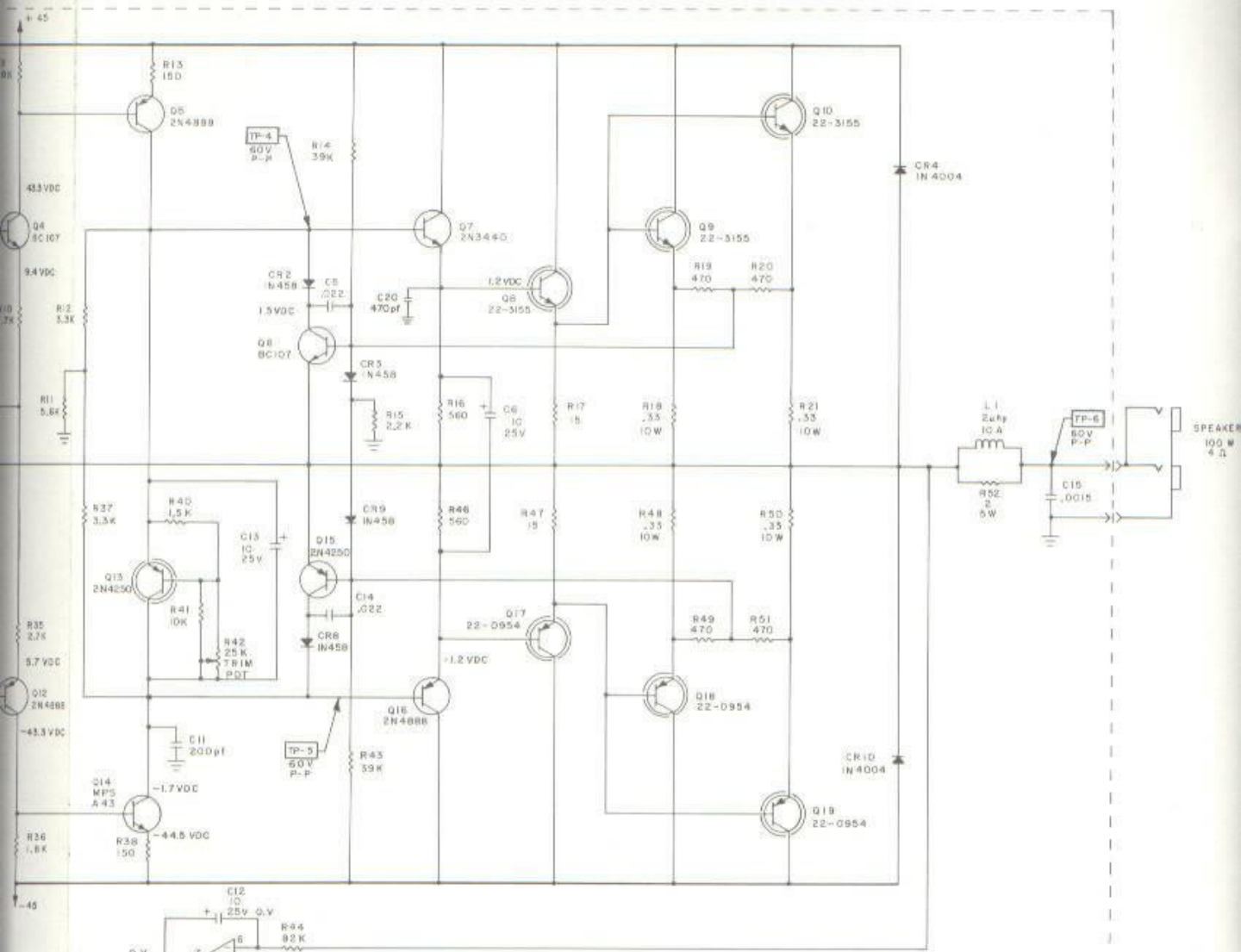

NOTES

1. RESISTORS ARE 1/2W, 5% UNLESS OTHERWISE NOTED. VALUES ARE STATED IN OHMS.
2. CAPACITANCE VALUES ARE STATED IN MICROFARADS UNLESS OTHERWISE NOTED.
3.  INDICATES TRANSISTORS MOUNTED TO HEATSINK ASSEMBLY.
4. DC VOLTAGES TAKEN WITHOUT LOAD AND WITHOUT INPUT.
5. IDLE CURRENT 90mw WITHOUT LOAD.

BETA SERIES POWER AMPLIFIER
AND POWER SUPPLY SCHEMATIC D-1092 a

BETA SERIES PREAMP TROUBLESHOOTING SUGGESTIONS

Problem	Possible Cause	Suggested Solution
No signal at T.P. 1	Short in Drive pot	Check with ohm meter—replace if shorted
	Short or open at input jack	Visual observation and scope—check to verify
	Short in op amp feed back loop	Check with ohm meter and/or scope
Signal at T.P. 4 but not at T.P. 5	Open Fet (Q104, Q106) Shorted Fet (Q103, Q105)	Replace open or shorted Fet's
	Fet's receiving incorrect information from logic control circuit	Locate where incorrect information is being produced and correct, possibly I.C.106 or I.C.103
Neither Channel is working	Check (+ and -) 15 volt supplies	Check supplies with DC meter Check supplies at power board
	Logic control I.C. bad (I.C.106 and/or I.C.103)	Check logic levels at logic gates—replace if bad
Signal at T.P. 8 but not at T.P.9	Check for open or short in connecting cables between accessory jacks and preamp board	
Reverb in one Channel but not both Channels	Defective reverb pot; open 680 resistor (R215, R214)	Replace defective pot or resistor
No reverb in either Channel	Open or short in reverb cables between preamp and reverb pan; defective reverb pan	Remove any short or open in cable. Replace defective reverb pan
Popcorn noise in mid tone	Noisy I.C. (I.C.109, I.C.111)	Replace I.C. and check for noise

SERVICE NOTES

PARTS LIST

Beta Series Amplifiers

	<u>Description</u>	<u>Sunn Part #</u>	
Integrated Circuits	RC 4558	22-4558	
	MC 14506, BCP C-MOS	22-4506	
	74C04-4069	22-7404	
Transistors	2N3055	22-3056	
	MJ0954	22-0954	
	BC107B-BC109C	22-0107	
	Tip 30	22-0030	
	Tip 29	22-0028	
	2N4250	22-4250	
	2N4888-2N5401	22-4888	
	MPSA43	22-5184	
	2N3440	22-3440	
	TIS74 NTL-FET	22-4303	
Diodes	IN4744-15V Zener	22-0150	
	IN4004	22-2070	
(LEDS)	IN458A	22-0458	
	Green	22-0223	
	Red	22-0222	
	Yellow	22-0227	
Rectifier	400 V 27A	19-0009	
Filter Capacitors	3000uf 50V	10-3090	
Controls			
	Drive	1 meg Blue Case 1 meg metal case	23-1273 23-1373
Bass, Mid, trble, level			
Master	100K 1in	23-1110	
Reverb	30K s Curve	23-6505	
Bias trim	25K	23-6508	
Jacks			
	Open circuit	11 Jack	67-0011
	Open circuit standard	11L Jack	67-0010
	Switching Jack	12 Jack	67-0012
Stereo Jack	12B Jack	67-0016	
Misc. Parts			
	Power switch		24-0108
	Power transformer		28-2105
	Fuse Holder		52-0340
	AC Cord		68-6500
	AC Cord Wrap		48-0000
	Pointer Knobs		69-6010
	Numbered Knob		59-5531
	Reverb Pan		29-0008

BETA SWITCH V

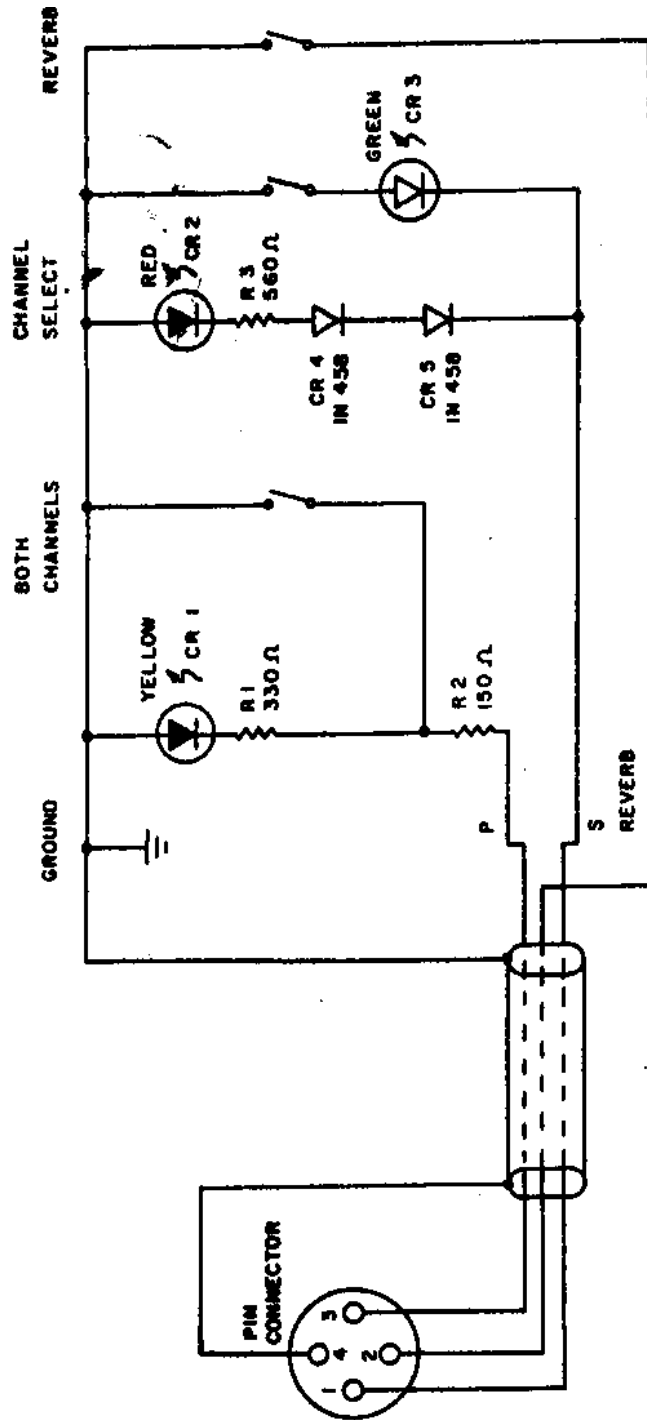

ALL RESISTORS 1/2 WATT, 5%